

DUPLEXVENT ADROIT PRO

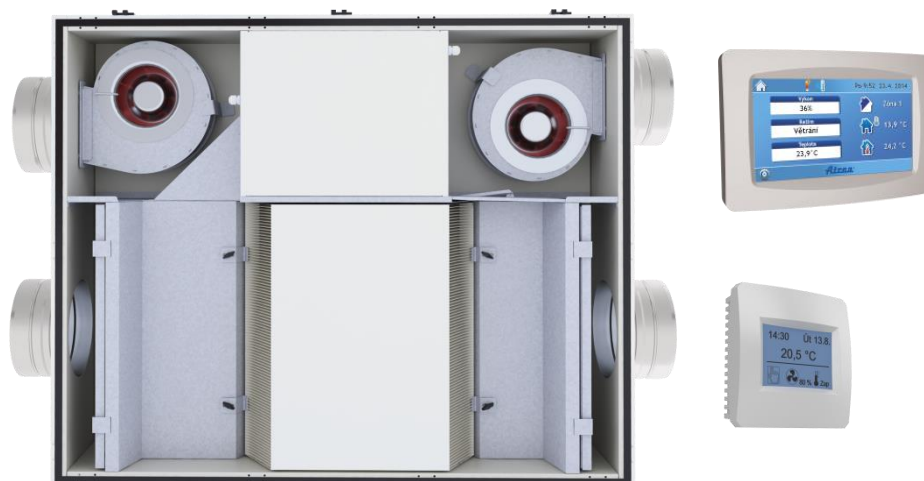

INSTRUCTION MANUAL

- ✓ Description
- ✓ Installation
- ✓ Service
- ✓ Maintenance

1. General information, explanations of used terms

1.1 Division of the Instructions

1	General information, explanations of used terms	6	Activation, warranty
2	Scope of supply, accessories, transport and storage	7	Maintenance and servicing of the unit
3	Description of the unit, technical data	8	Possible failures and solutions to such failures
4	Installation, fitting of the unit	9	Annexes
5	Measurement and control, wiring	10	

1.2 Table of contents

1.	General information, explanations of used terms	2
1.1	Division of the Instructions	2
1.2	Table of contents.....	2
1.3	Introduction	5
1.4	Description of the unit	5
1.5	Abbreviations used, marking	5
1.6	Important warnings.....	5
1.7	Intended scope of use.....	6
2.	Scope of supply, accessories, transport and storage	6
2.1	Storage and transport	6
2.2	Content of the supply	6
2.3	Mandatory accessories	6
3.	Description of the unit and technical data.....	7
3.1	Technical data.....	7
3.2	Division of the unit by built-in control system	7
3.3	Description of the main parts of Duplexvent Adroit Pro units	8
3.31	Sketch and description of the main parts of the DV170/DV370/DV570 units with Basic control system	8
3.32	Sketch and description of the main parts of the DV170/DV370/DV570 units with Web/Web CF control system.....	8
3.33	Sketch and description of the main parts of the DV280/DV380/DV580 units with Web/Web CF control system.....	9
3.34	Sketch and description of the main parts of the DV280/DV380/DV580 units with Basic control system	9
3.4	Side entry units: DV170/DV370/DV570.....	10
3.5	Top entry units: DV280/DV380/DV580.....	10
3.6	Description of the Air Filters	10
4.	Installation of the Unit.....	11
4.1	Installation of DV170/DV370/DV570	11
4.2	Installation of DV280/DV380/DV580	12
4.3	Distance separations.....	12
4.4	Condensate drain connection	12
4.41	Condensate drain in general for Adroit Pro units	13
4.42	Condensate drain connection for DV170/DV370/DV570	13
4.43	Condensate drain connection for DV280/DV380/DV580	14
4.5	Power supply, entrance for cabling	14
4.6	Installation of optional accessories – reheater and preheater	14
4.7	Installation of controllers	15
4.71	BC1 controller	15
4.72	BC2 controller	15
4.73	WB1 Touch controller	15
4.74	WB2 controller	16

4.8	Handedness change for DV170/DV370/DV570 units.....	16
4.81	Handedness change for units with Web control system	16
4.82	Handedness change for units with Basic control system.....	16
5.	Measurement and control, wiring	18
5.1	Web control system with WB1 Touch controller.....	18
5.11	Connecting the controller to the unit.....	18
5.12	Controller description and functions	19
5.13	Starting the display	19
5.14	Symbols and their meanings	20
5.15	Symbols on the main screen	20
5.16	Navigation symbols	20
5.17	Symbols fixed on the main screen.....	21
5.18	“Power” block.....	21
5.19	“Mode” block.....	21
5.110	List of modes (defined by the type and configuration of the unit).....	21
5.111	“Temperature” block “	22
5.112	“Zone” block.....	22
5.113	User settings.....	22
5.114	Parameters.....	22
5.115	Control.....	22
5.116	Switching between HS/NHS	22
5.117	HS/NHS temperature.....	23
5.118	Current season	23
5.119	Control settings.....	23
5.120	Blocking input IN1 (No/HS /NHS)	23
5.121	Blocking input IN2 (No/HS /NHS)	23
5.122	Heating hysteresis	23
5.123	Cooling hysteresis	23
5.124	Bank holidays	23
5.125	School holidays	24
5.126	Holiday/Party	24
5.127	Weekly program setting.....	25
5.128	Day copying.....	25
5.129	Network setting.....	26
5.130	Texts.....	26
5.131	Display settings	26
5.132	Time zone setting	26
5.133	Daylight saving time (summer time)	26
5.134	SW information (unit type, configuration, specifications, version).....	27
5.135	Filter replacement indication.....	27
5.136	Table of alarms and notifications	27
5.137	Forgetful operator	29
5.138	Bypass dampers.....	29
5.2	Web control system with WB2 controller.....	29
5.3	Basic control system with BC1 controller	29
5.31	Performance settings.....	30
5.32	Unit’s operating modes	30
5.33	Description of controls	30
5.34	Basic menu.....	30
5.35	“MODE“ menu (operating mode)	31
5.36	Menu „PROGRAM“ (weekly program).....	31
5.37	“PARTY“ and“ HOLIDAY” menu (temporary operating modes)	32
5.38	“REHEAT” menu (air reheat)	32
5.39	User system settings	32
5.310	“FILTER“ menu.....	33
5.311	“TIME” menu.....	33
5.312	“INPUT” menu	33
5.313	“SWITCH” menu (binary input DI1).....	33
5.314	“SENSOR“ menu (analogue input IN1).....	33
5.315	“LIMIT” menu	34
5.316	“TEMPERATURE” menu	34
5.317	“DISPLAY” menu	34
5.318	“LANGUAGE” menu	34
5.319	Automatic ventilation modes.....	35

5.320	Constant pressure in a supply line.....	35
5.321	Warning messages.....	35
5.322	Supply air reheat mode	35
5.323	Description of fault messages and their causes	36
5.4	Basic control system with BC2 controller	37
5.41	Description of functions í	37
5.42	Performance settings.....	37
5.43	Description of controls	37
5.44	Limiting ventilation capacity	37
6.	Commissioning the system, warranty	38
6.1	Activation	38
6.2	Warranty	38
7.	Maintenance and Servicing of the Unit.....	38
7.1	Maintenance and Servicing of the Unit.....	38
7.2	Changing air filters G4/F7 – cloth type	38
7.21	Change procedure.....	39
7.3	Changing air filters G4/F7 – cartridge type.....	39
7.31	Change procedure.....	39
7.4	Cleaning plastic heat recovery exchanger	40
7.41	Heat recovery exchanger release.....	40
7.5	Controller cleaning	40
7.6	Cleaning other parts of the unit – minor maintenance.....	40
7.7	Spare parts, repairs.....	40
7.8	Unit failures, safety instructions.....	40
8.	Possible failures and solutions to such failures	41
8.1	Possible failures and solutions to such failures	41
9.	Annexes	42
9.1	Product fiche	42
9.2	Indicative wiring diagram of Basic control system with BC1 and BC2 controller	43
9.3	Indicative wiring diagram of Web control system – internal connection	44
9.4	Indicative wiring diagram of web control system with WB1 Touch controller	45

1.3 Introduction

These Instructions are intended to be used exclusively for the Airflow Adroit Pro heat recovery ventilation units including Basic and Web built-in control modules.

1.4 Description of the unit

This is a compact ventilation unit with heat recovery. The unit consists of the housing, pair of fans, heat recovery exchanger, built-in control module, by-pass damper, filters, thermostats, and sensors.

Duplexvent DV170/DV370/DV570 – the unit is intended to be installed only under ceiling in a versatile position.

Duplexvent DV280/DV380/DV580– the unit is intended to be installed only on the wall.

1.5 Abbreviations used, marking

E1(ODA)	-fresh air supply from the outside to the unit
E2(SUP)	-fresh air supply after recovery to the building
I1(ETA)	-degraded air outlet from the building
I2(EHA)	-air exhaust from the unit to the outside

1.6 Important warnings

- The Duplexvent series ventilation units with heat recovery are intended to provide comfort ventilation for areas with the standard environment and with relative humidity below 90%. If the unit is used for any other purpose(e.g.: dehumidification, dust suction, etc.) or is not properly operated in accordance with the instructions contained in the Operating and Maintenance Instructions, the manufacturer does not undertake responsibility for any damage incurred.
- The units shall only be installed in indoor area, within the heated envelope of residential buildings.
- The unit may only be operated by adults sufficiently familiar with the "Instructions for Installation, Use and Maintenance".
- The user is prohibited to arbitrarily interfere with or modify any part of the unit and, in particular, it is prohibited to interfere with distribution of electricity! The unit must not be used for construction site dehumidification or for dust, building material and other solid product extraction.
- Activation and repairs of the unit may only be performed by the staff of specialised service companies with the appropriate qualification. Unprofessional activation and repairs may result in significant risks and loss of warranty.
- Make always sure that the unit is disconnected from the electric power supply prior to each opening of the unit door for the purpose of cleaning, filter cloth change or basic maintenance, and ensure that it cannot be reconnected by any other person.
- The unit must be firmly attached to the HVAC ducts with the minimum length of 2 m on the discharge side of fans to protect against injury caused by fan wheel. The ducts must be attached to the unit as to be able to dismantle the unit using only tools.
- The unit may only be installed in rooms with temperature above 10°C and with relative humidity below 60% at 20°C.
- If the unit was out of operation for long period of time, caution should be exercised when reactivating the unit.
- The unit, intended to be used in the standard environment, may be used in the range of ventilation air temperatures from -25°C to +45°C and relative air humidity below 90%, in the environment free of fire or explosion hazard of flammable gases and vapours that do not contain organic solvents or aggressive substances, which could cause damage to machinery components of the unit. In the event of danger of temporary infiltration of such gases and vapours into the piping system (e.g. gluing floors, coating), the unit shall be disconnected ahead in good time.
- Electrical connections, activation and adjustment of the unit may only be carried out by a person with the appropriate electro technical qualification. The units shall be protected by means of circuit breaker 1 x 10A char. C.
- In the case of use of the additional protection against hazardous contact of live and non-live parts and current protection, it is necessary to use a special current protector intended for the circuits with frequency converters and switched power supplies. It is the protector sensitive to alternating as well as pulse with residual currents, resistant to current surges of 5 kA.
- Please read thoroughly the Instructions for Installation, Use and Maintenance prior to the installation and activation of the unit!
- The unit and all accessories shall be installed and used in accordance with the design, with the manufacturer's technical specifications and appropriate applicable legislation and technical standards.
- The unit must not be installed and used in aggressive environment, which could attack both external and internal components.
- Before putting the unit into continuous operation, it is necessary to obtain an initial revision report for the power supply to the unit. Furthermore, it is necessary to fill in the activation report and to make the operators familiar with the unit.
- In the case of failure, the unit should be immediately disconnected from the power supply!
- Comply with all the principles of occupational safety (including occupational safety for work at heights and work with suspended loads) and use the appropriate working and protection equipment for handling and installation of the unit.
- Make sure that the installation does not cause damage or deformation to the unit's housing.
- The unit combined with a hot-water based heater (optional accessory) shall be continuously connected to the power supply to ensure the anti-freeze protection of the hot-water based heater. In the case of longer power failure, the

heating fluid shall be drained from the hot-water based heater. It is recommended to drain the heating fluid from the heater using compressed air and not by gravity flow!

The manufacturer is not liable in respect of damages caused by unprofessional installation of the unit contrary to the Installation Instructions and contrary to standard practice for the installation of HVAC units and control systems

1.7 Intended scope of use

The Adroit Pro units with heat recovery are intended for the comfort ventilation, solely for residential buildings – houses and flats. They can be further used within offices, educational facilities, and small-scale plants.

If the unit is used for any other purpose or is not properly operated in accordance with the instructions contained in the Operating and Maintenance Instructions, the manufacturer does not undertake responsibility for any damage incurred.



2. Scope of supply, accessories, transport and storage

2.1 Storage and transport

- The unit may only be stored in dry, clean rooms at ambient temperatures from 0°C to 50°C. The stacking of the unit is prohibited. The unit shall be stored on a flat, hard surface so as not to damage the unit or the packaging.
- During storage, the unit shall be kept in its original, intact packaging including all spacers, binding and marking elements.
- The transport packaging may be removed not earlier than at the time of installation in the final place. The surface in the final place shall be checked for cleanliness prior to the installation. Furthermore, the distribution board shall be checked for cleanliness and integrity. If necessary, the appropriate cleaning shall be carried out.
- During transport, the unit shall be protected against potential fall, mechanical damage, infiltration water and other adverse influences, which could result in damage to the unit or its packaging.

2.2 Content of the supply

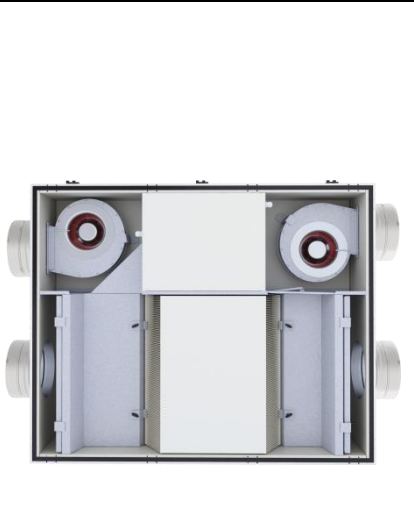
The complete set always contains the HVAC unit of the given type, Web/Basic series built-in control system, pair of G4 basic filters, condensate drainage assembly (flexible hoses and adapters for the connection to the prepared point on the unit), Operation and Installation Instructions for the unit, and the energy label related to the specific product.

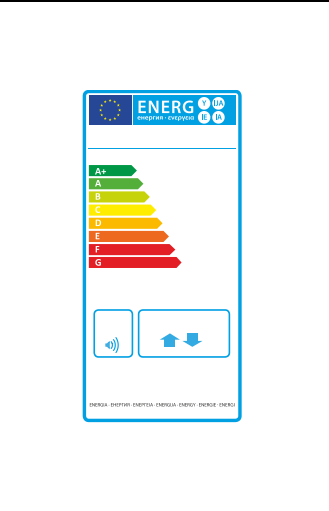
The supply of Duplexvent Adroit Pro contains:			
			
HVAC unit of the given type	Condensate drainage assembly	Operation and Installation Instructions, technical data	Energy label

2.3 Mandatory accessories

The mandatory accessories relate to the **Basic type control system**; one of the BC1 or BC2 controllers should be always ordered to this specification. **Without this controller, the HVAC unit will not work after connecting to main power.**

90000409	BC1	Touch controller for the units with the CP control system. It provides the comfort control of all functions of the unit and it is supplied separately. Wall-mounted type
90000408	BC2	Mechanical controller. It provides the comfort control of unit performance and the failure warning indication. It is not possible to set the weekly program and the selection modes – party, holiday. Wall-mounted type

3. Description of the unit and technical data

3.1 Technical data

Duplexvent Adroit Pro		DV170	DV370	DV570
Energy class	m ³ /hour	A+ ¹	A+ ¹	A+ ¹
Maximum flow *	m ³ /hour	175	370	570
Sound power to the surrounding L _{WA}	dB	37	38	42
Maximum heat recovery efficiency	%	94	95	94
Height H	mm	290	290	370
Width S	mm	655	930	930
Length (without ports) L	mm	840	1116	1290
Diameter of connecting ports		D160	D200	D250
Weight	kg	40	48	59
By-pass		YES		
Power supply	V	230 / 50 Hz		
Filter class		G4 (alter. F7)		
Condensate drain	mm	2x14 (depending on position)		

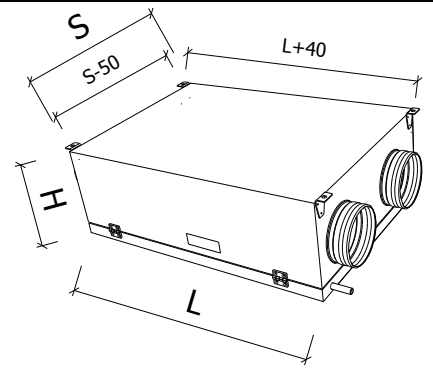

Duplexvent Adroit Pro		DV280	DV380	DV580
Energy class	m ³ /hour	A+ ¹	A+ ¹	A+ ¹
Maximum flow *	m ³ /hour	285	365	565
Sound power to the surrounding L _{WA}	dB	36	36	42
Maximum heat recovery efficiency	%	94	95	94
Height (without ports) V	mm	1000	1000	1080
Width S	mm	617	617	928
Depth H	mm	490	490	509
Diameter of connecting ports		D160	D160	D200
Weight	kg	49	49	58
By-pass		YES		
Power supply	V	230 / 50 Hz		
Filter class		G4 (alter. F7)		
Condensate drain	mm	1x14 (depending on position)		

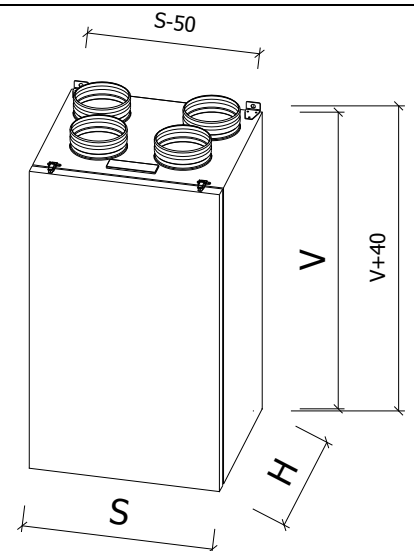

* Values must be adjusted according to the curves of individual performance graphs

¹ All types of the control system built in the unit contain at least two inputs for the connection of electrical signals as standard, which are a result of handling of light by human or of any other device that automatically controls the unit performance. The inputs must be connected at all times or other types of sensors must be connected instead of them (e.g. CO₂, VOC, RH, etc.).

3.2 Division of the unit by built-in control system

On the basis of a built-in control system, each unit may be divided into three types:

- Basic** – basic digital control system, which contains functions for the comfort control without webserver
- Web** – digital control system, which contains functions for the comfort control including web-based connection
- Web CF** – digital control system, which contains functions for the comfort control including web-based connection and constant air flow control

3.3 Description of the main parts of Duplexvent Adroit Pro units

3.31 Sketch and description of the main parts of the DV170/DV370/DV570 units with Basic control system

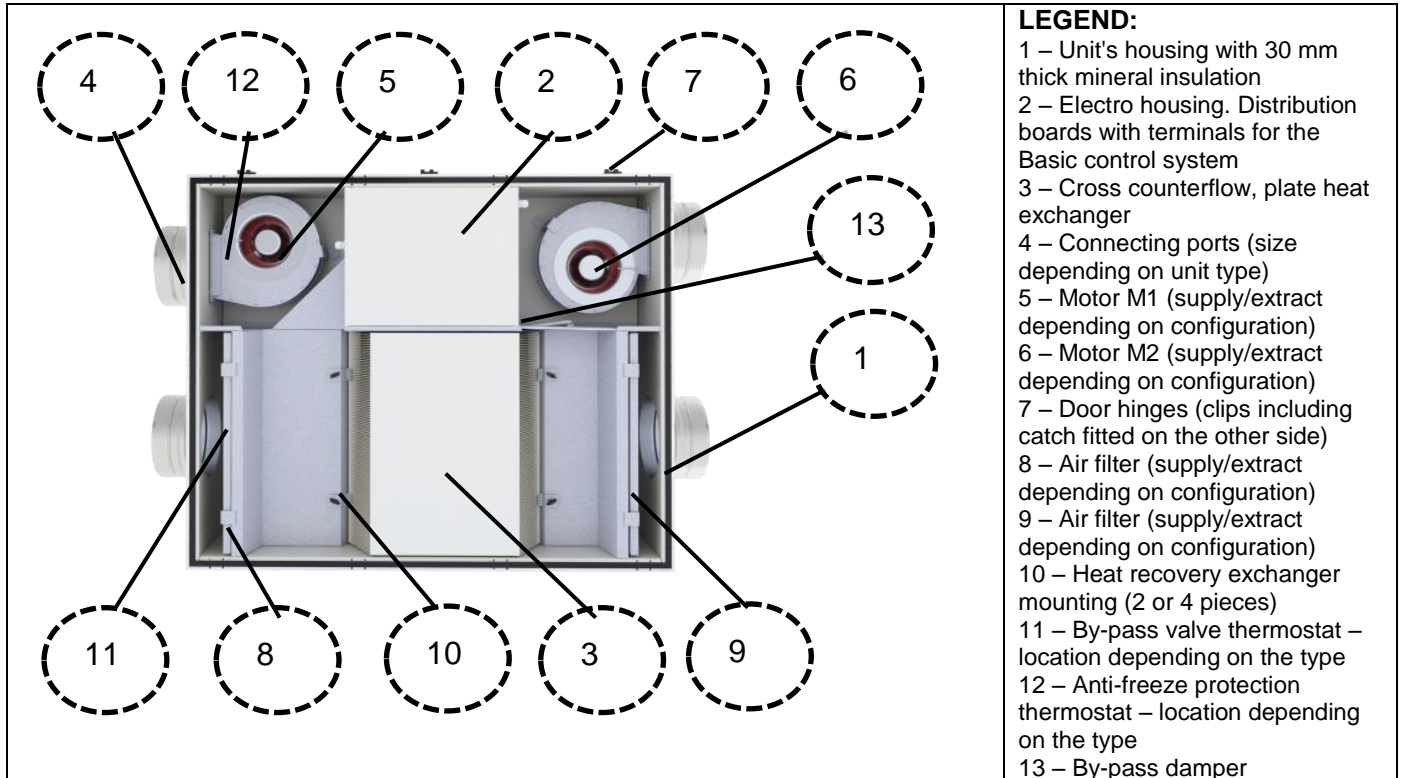

3.32 Sketch and description of the main parts of the the DV170/DV370/DV570 units with Web/Web CF control system

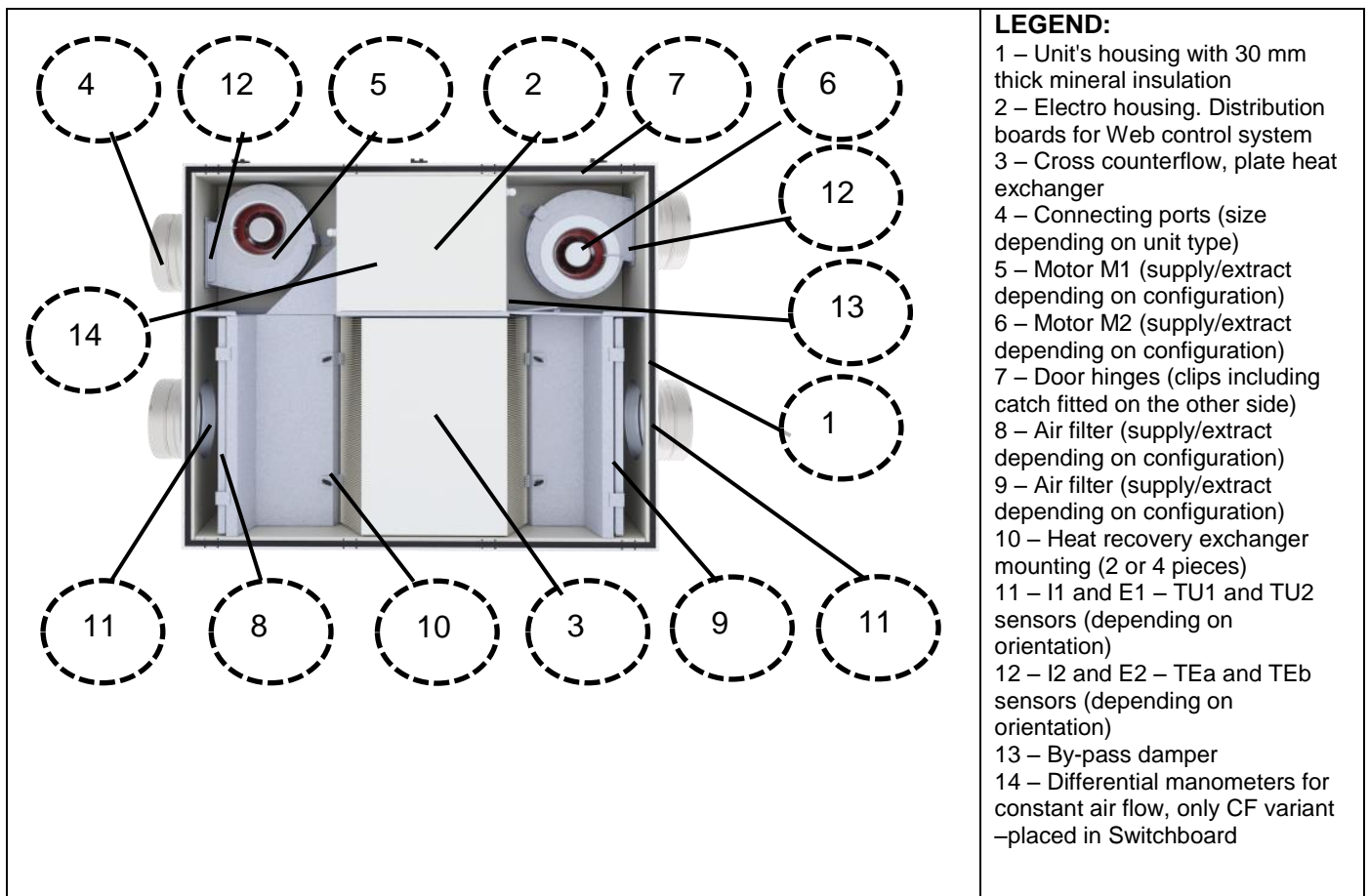

3.31 **Sketch and description of the main parts of the DV280/DV380/DV580 units with Web/Web CF control system**

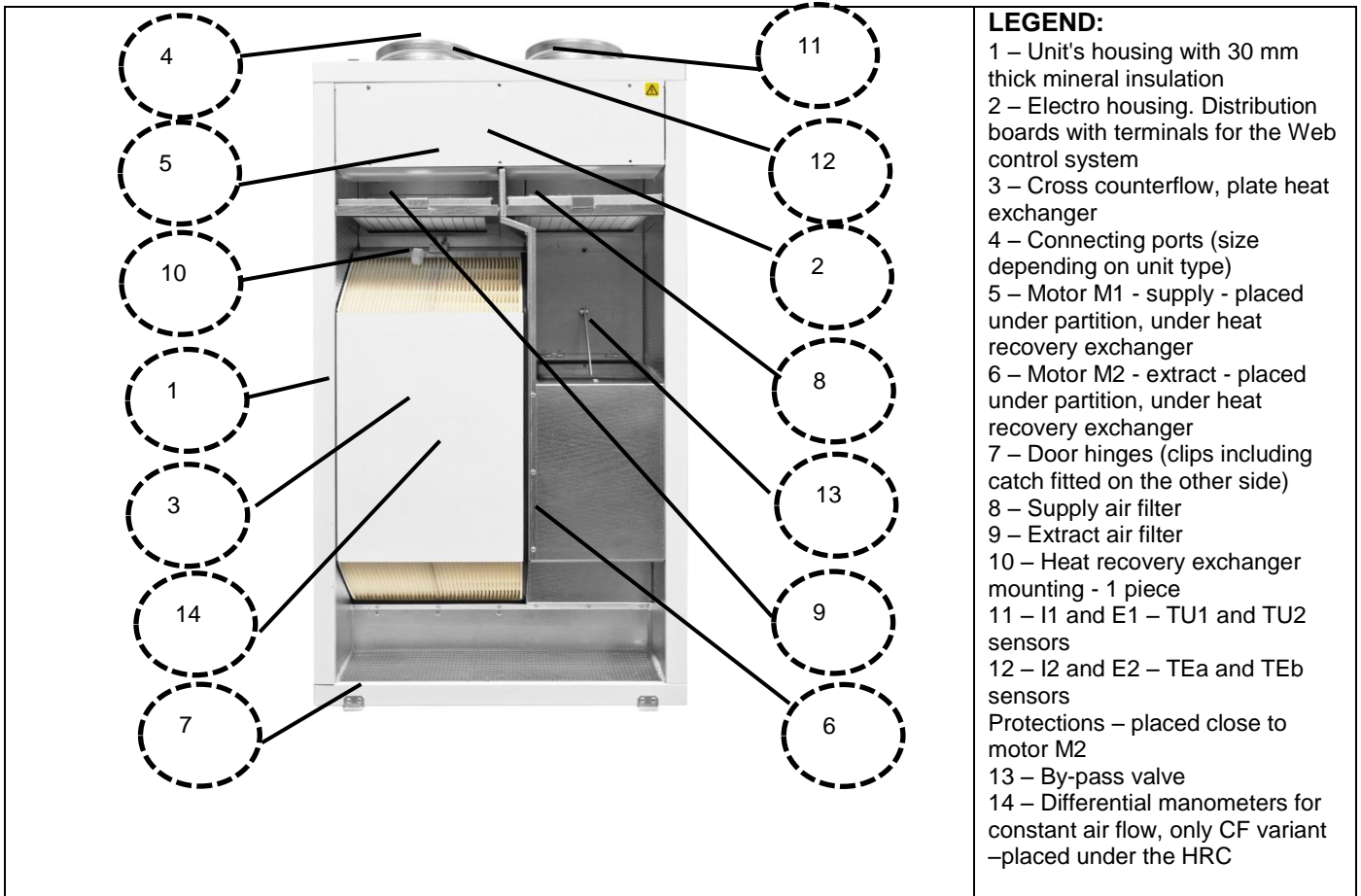

3.32 **Sketch and description of the DV280/DV380/DV580 units with Basic control system**

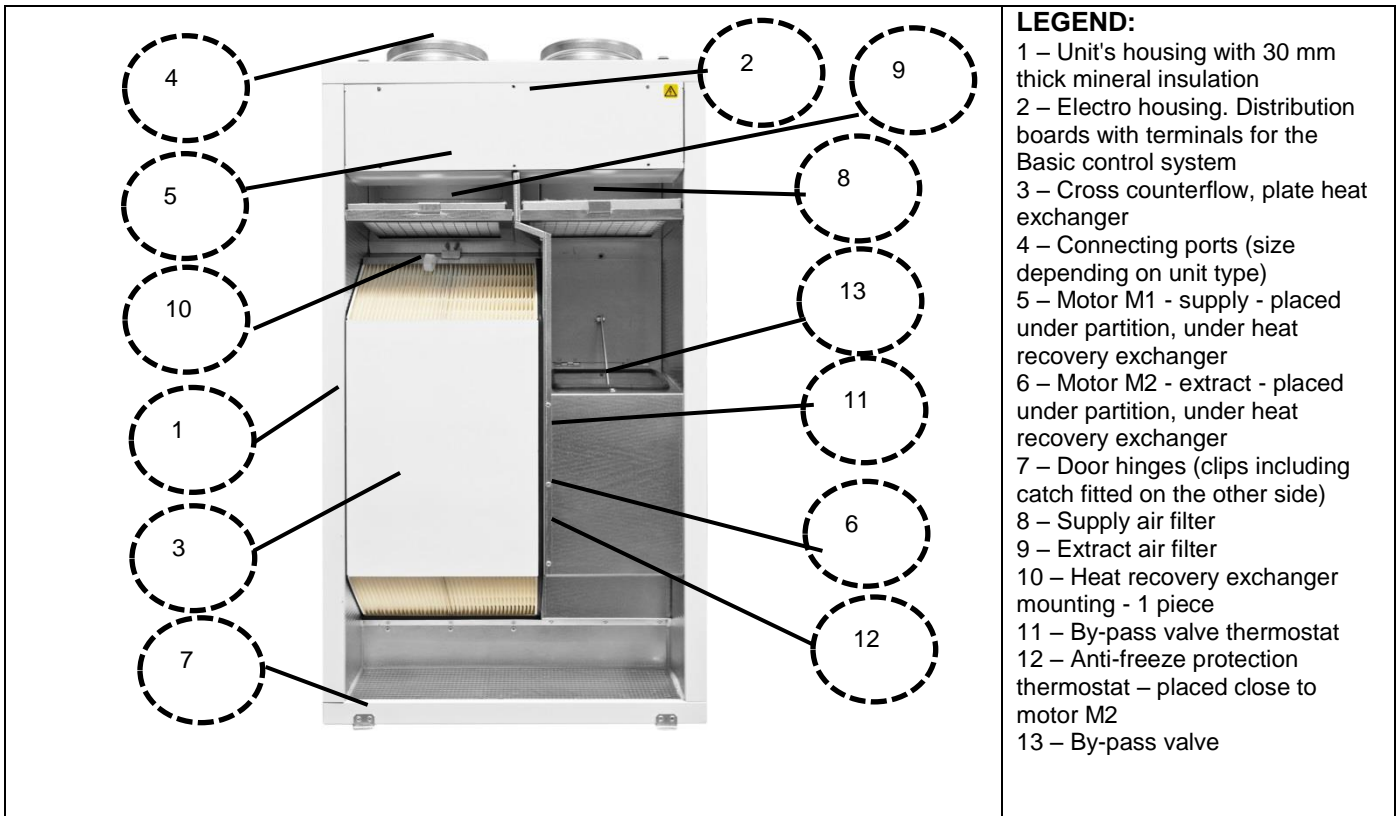

3.4 Side entry units: DV170/DV370/DV570

The units are manufactured as a versatile type, i.e. they have an option of the mirror-wise change and subsequent choice from type 10 or 11. The change is made by type of the control system as described in Chapter 4 of the Instructions.(plan view)

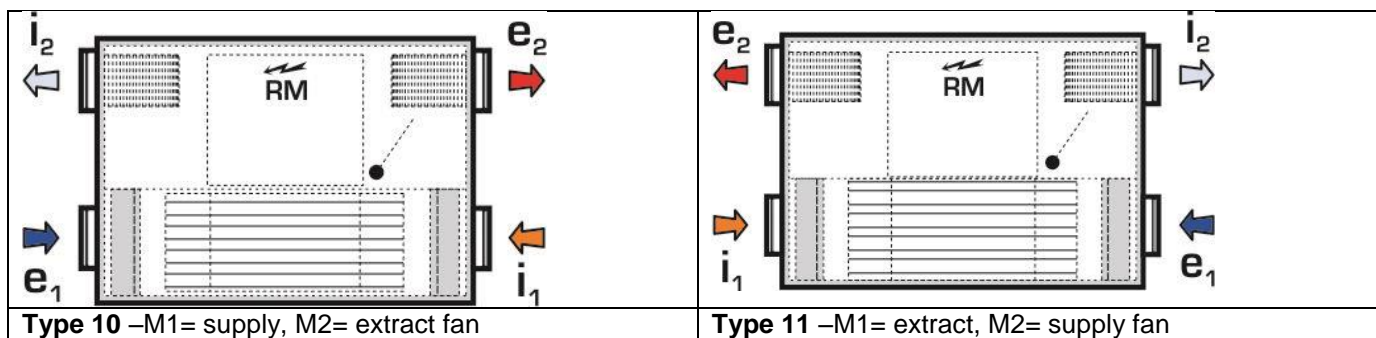

3.5 Top entry units: DV280/DV380/DV580

The units are manufactured only in a single type – all connecting ports facing upwards –type 10

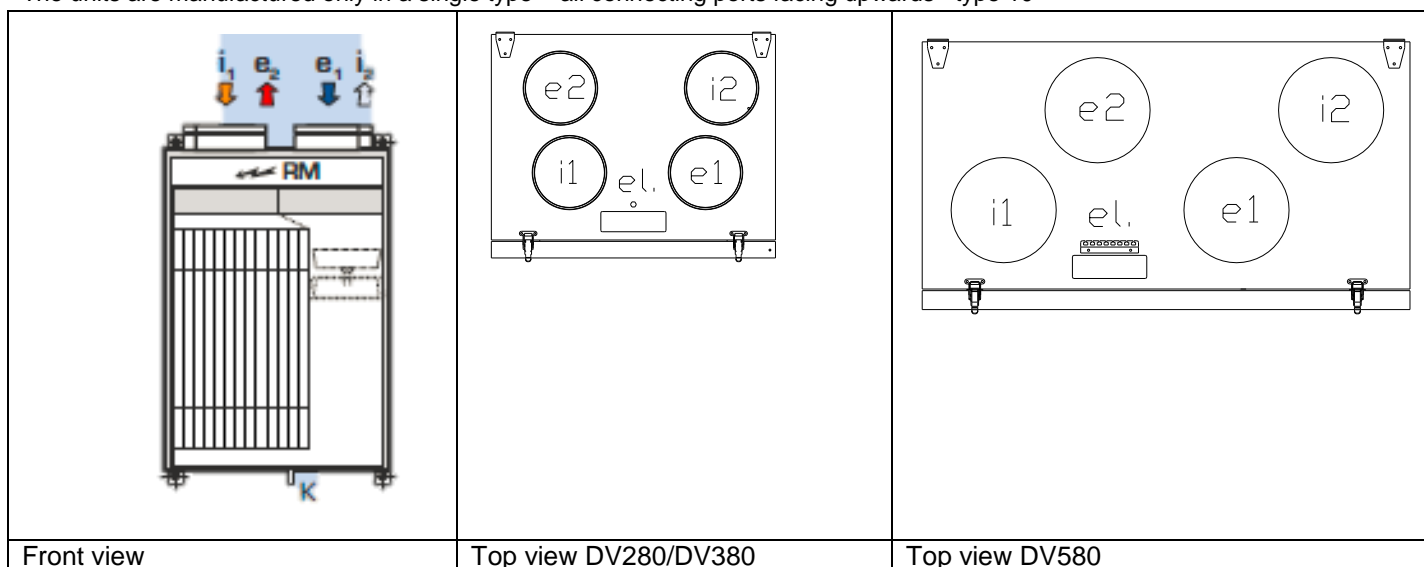

3.6 Description of the Air Filters

The standard types of the unit are supplied with a cloth-type filter class G4 in a galvanized frame, optionally a cloth class F7, or cartridge filters G4 / F7 can be additionally purchased.



4. Installation of the Unit



The unit may only be installed and fitted by a specialised organisation, trained within the Airflow systems of the given category. The unit may only be fitted in rooms intended for that purpose and as described in the Instructions.

During installation, make sure that the power supply is disconnected!

4.1 Installation of DV170/DV370/DV570 units

The unit may only be fitted in an under-ceiling position, with the necessary slope to ensure condensate drainage. The unit is suspended under ceiling by means of four suspensions – firmly attached to the unit. Suspend the unit and then fill the joints as required

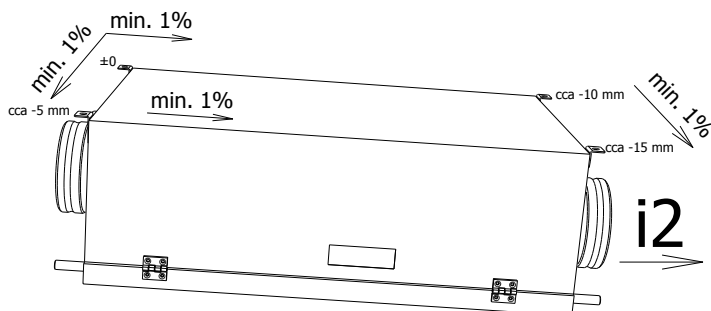

The under-ceiling units must be installed at the angles as shown in diagrams – toward outlet i2!

Suspend the unit using the threaded bar M8, ideally through silent blocks (optional accessories, part number: 90000826 are available).

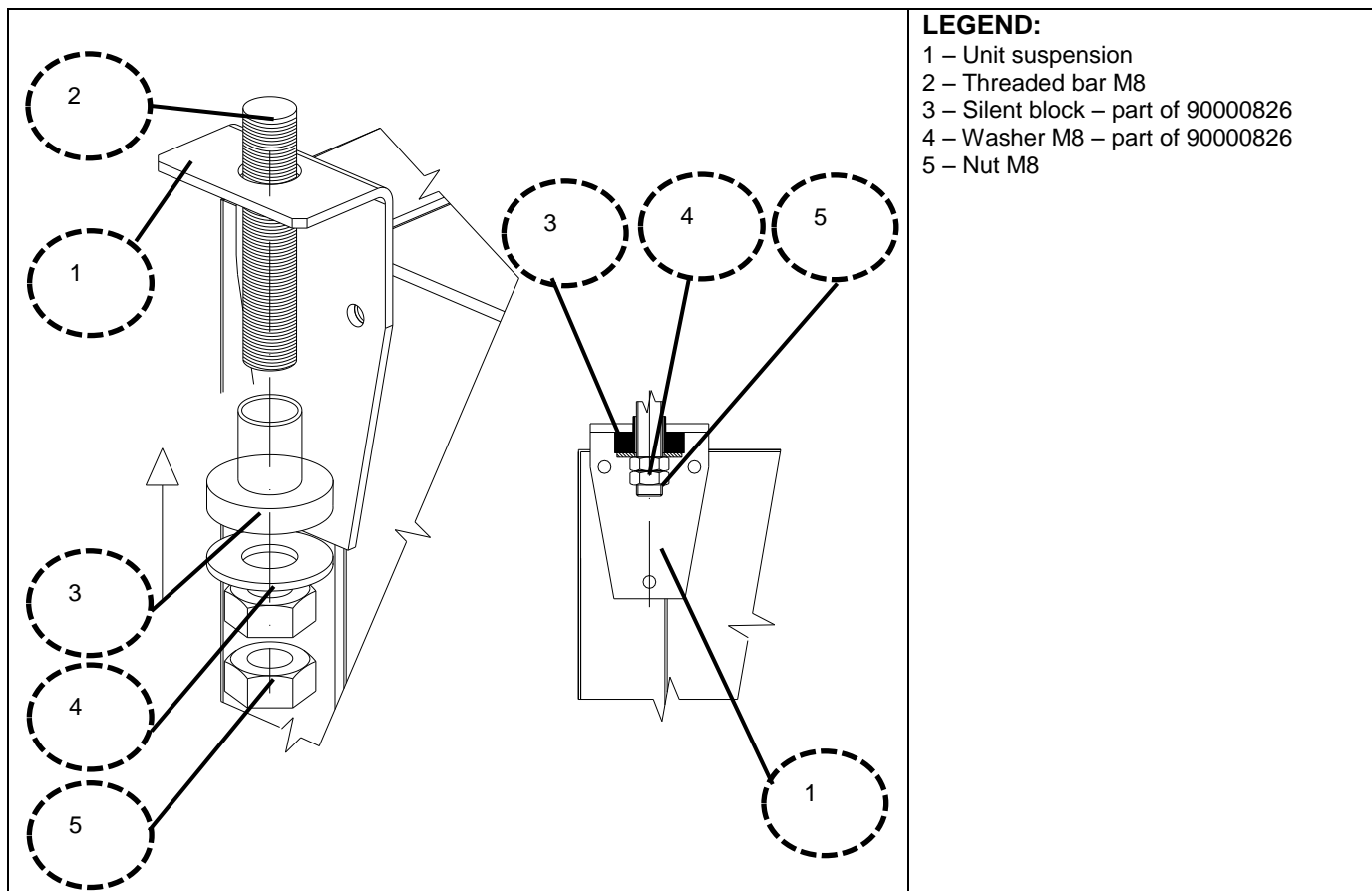

4.2 Installation of DV280/DV380/DV580 units

The unit may only be fitted in a wall-mounted position without sloping. The unit is suspended on the wall by means of two suspensions – firmly attached to the unit. Suspend the unit and then check the vertical position and, if necessary, secure it.

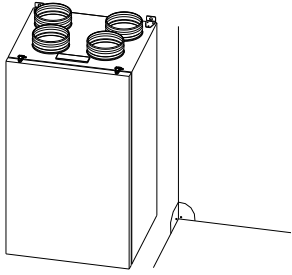

Fit the vertical units in the perpendicular!

4.3 Distance separations

They are the minimum recommended distances.

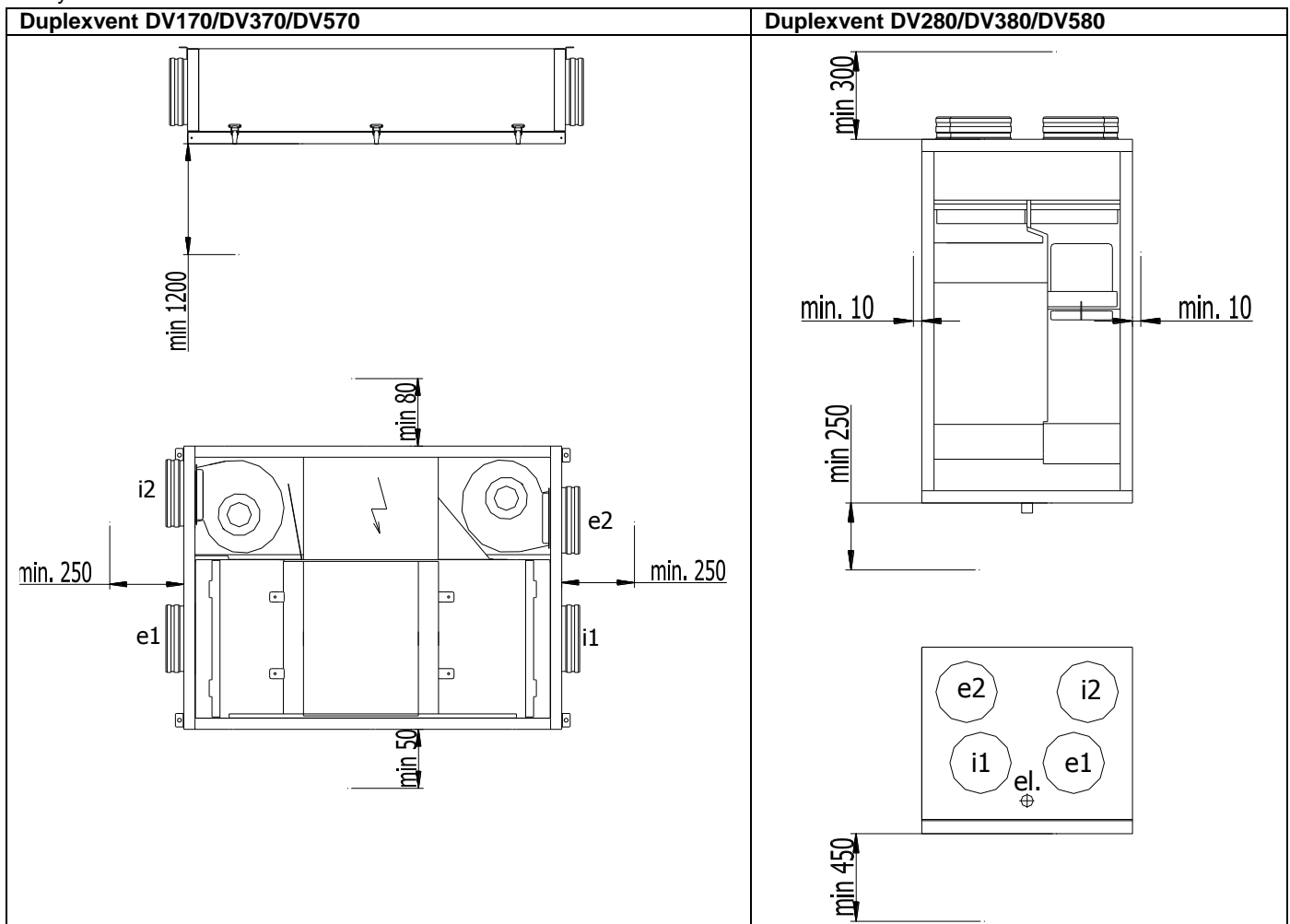

4.4 Condensate drain connection

Connection of the condensate drain forms an integral part of installation of all Duplexvent Adroit Pro units, of all types and configurations. Connect the unit with the use of a set, which is included in the package of all units. The condensate drain is always connected closest to the exhaust air outlet I2. Unused condensate drains must remain sealed. The condensate drain piping must be connected so that the handling of unit does not cause damage to the piping. The condensate drain must be disconnected before opening of a door. The pipe inlet is made into a sewer system of a house.

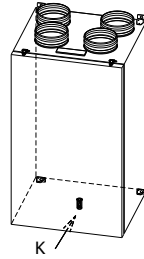
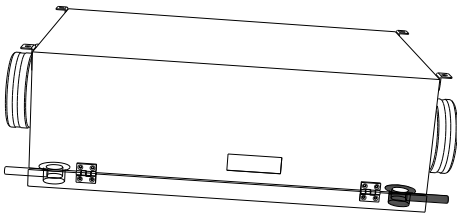

Duplexvent DV170/DV370/DV570 – under-ceiling type

On the lower side (exhaust i₂) connect
 On the higher side (e₂) blind with a plug

Duplexvent DV280/DV380/DV580 – from the bottom side

4.41 Condensate drain in general for Duplexvent Adroit Pro

The condensate drain must be equipped with a siphon and led into a sewer system. The siphon must be permanently wet! After the unavailability time of the unit and reactivation, always make sure that the siphon is wet and the condensate drain is clear.

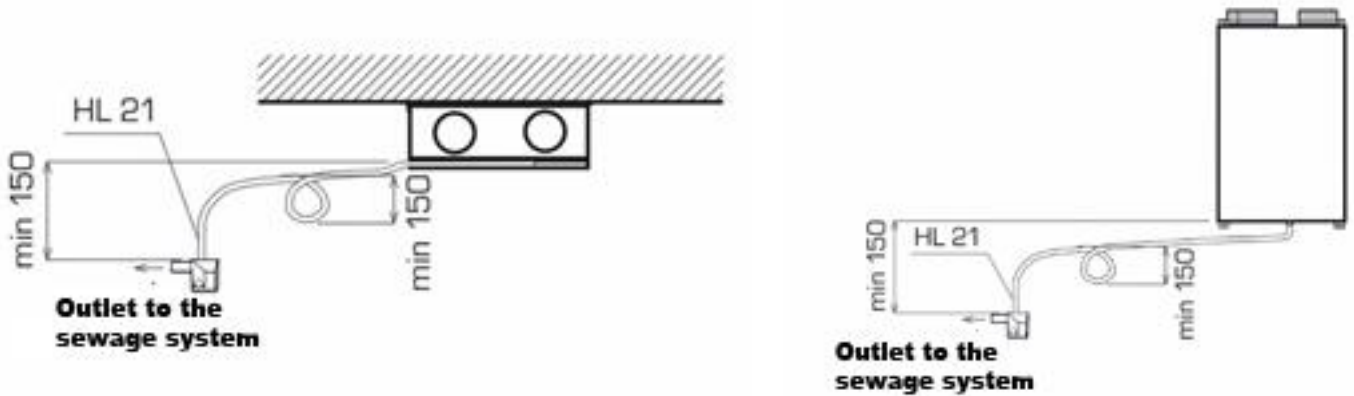

Adroit Pro – under-ceiling type

The condensate drain must be equipped with a siphon and led into a sewer system. The siphon must be permanently wet!

Adroit Pro – vertical type

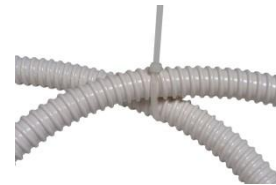

Siphon on a flexible rube

Siphon attachment detail – plastic clamp

4.42 Condensate drain connection for Duplexvent DV170/DV370/DV570

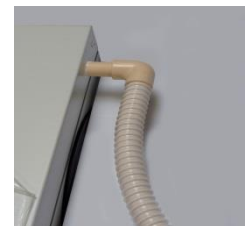
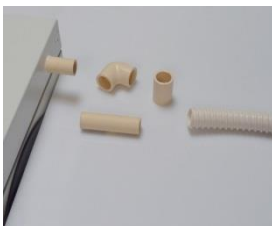

Condensate drain from the door on the side
 i₂+ condensate drain accessories

Condensate drain connection with a 90°
 bend – to slide in the hose

Slide in the hose, secure with a clamp
 (clamp supplied by an installation
 company)



Condensate drain connection straight with a
 socket – to slide in the hose

Slide in the hose, secure with a clamp
 (clamp supplied by an installation
 company)

Condensate drain disconnection from
 the unit

4.43 Condensate drain connection for Duplexvent DV280/DV380/DV580

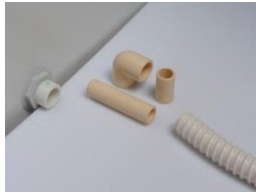

Condensate drain from the bottom side of the unit + condensate drain accessories



Condensate drain connection straight with a socket – to slide in the hose



Slide in the hose, secure with a clamp (clamp supplied by an installation company)



Condensate drain connection with a 90° bend – preparation for sliding-in of the hose



Slide in the hose, secure with a clamp (clamp supplied by an installation company)



On request for disconnection of condensate, remove hoses including connecting tube

4.5 Power supply, entrance for cabling

For all sizes and types of Duplex EC5/ECV5 units, the grommet is fitted in the same place. Make all electrical connections after complete mechanical connection.

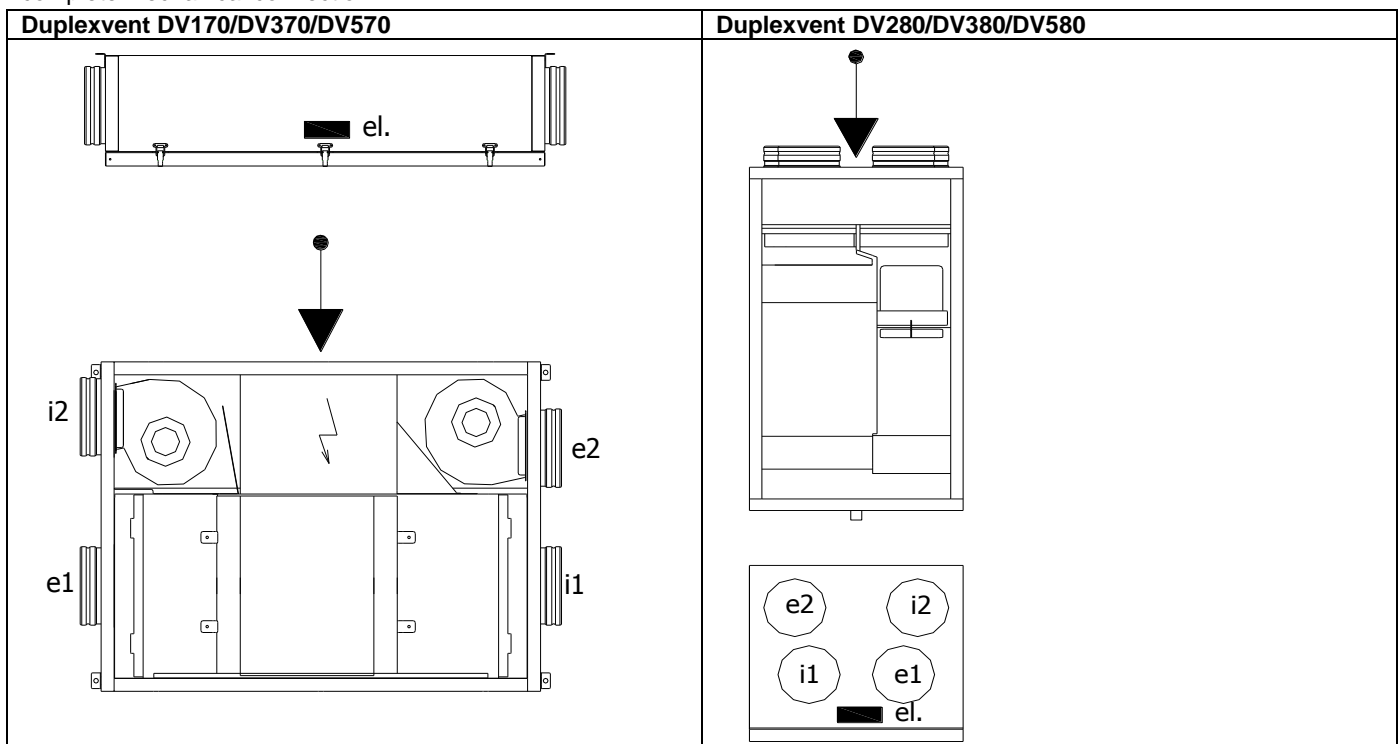

4.6 Installation of optional accessories – reheater and preheater

The following built-in or external preheaters or reheaters can be connected to the units:

- External EPO-PTC electric preheater (only for the Basic control system), placed in a fresh air inlet line to the building. The preheater is equipped with an autonomous control system – thermostats and protections for safe running.
- External EPO-V electric air preheater (only for units with the Web control system) in a fresh air supply line to the unit.
- Integrated EDO5.RD5 or EDO5.CP electric preheater for the Web or Basic control system, respectively. It is not possible to interchange the individual types. **Placement in the unit is allowed only at the preliminary prepared point in a fresh air inlet line; the installation may only be carried out by a trained technician of the Airflow.**
- Integrated EDO5.RD5 or EDO5.CP electric reheater for the Web or Basic control system, respectively. It is not possible to interchange the individual types. **Placement in the unit is allowed only at the preliminary prepared point in a fresh air supply line; the installation may only be carried out by a trained technician of the Airflow.**
- External EPO-PTC electric reheater (only for the Basic control system), placed in a fresh air outlet line to the building. The preheater is equipped with an autonomous control system – thermostats and protections for safe running.

- External EPO-V electric reheater with an ADS 120 sensor (only for the Web control system), placed in a fresh air outlet line to the building.
- External TPO EC–THV hot-water based reheater, which includes an electric throttle valve with a 24 V power supply and 0 – 10 V control. It is necessary to add an ADS 120 sensor (only for the Web control system), placed in a fresh air outlet line to the building.

The instructions for fitting, connection and wiring diagram for such external units are included in packages of those elements.

Electric heater types other than the above cannot be used with the Duplexvent Adroit Pro ventilation units!!!

4.7 Installation of controllers



Caution: Disconnect the power supply from the ventilation unit before installation or removal of the controller. Handling of energised controller could result in electric shock or in damage to the controller. It applies to all types of controllers.

The individual types of controllers are compatible only with the given type of control system and their change among the types of control system can cause damage to the unit itself.

4.7.1 BC1 controller

The BC1 type for the complete control and programming of the unit with the **Basic type control system – it is always supplied separately as required accessories**. It is supplied to be installed on the wall, optionally to be fitted on a flush-mounted junction box.

It is advisable to install the controller on the wall at a height 1.3 to 1.5 m in an easily accessible, illuminated and dry place; it must not be installed in close proximity to heating units and in close proximity to radiating surfaces. Use a shielded cable (SYKFY 5x2x0.5) to make connection. On request for greater distance between the controller and the ventilation unit, the cable should be replaced/extended (maximum 25 m). The controller is installed by a technician of a specialised electrotechnical company. **Caution:** Disconnect the power supply from the ventilation unit before installation or removal of the controller.

CPA	Wall mounting

4.7.2 BC2 controller



The BC2 type for the mechanical control – power and temperature control. Unit with the **Basic type control system – it is always supplied separately as required accessories**. It is supplied to be installed on the wall, optionally to be fitted on a flush-mounted or wall-mounted junction box.

It is advisable to install the controller on the wall at a height 1.3 to 1.5 m in an easily accessible, illuminated and dry place; it must not be installed in close proximity to heating units and in close proximity to radiating surfaces. Use a shielded cable (SYKFY 5x2x0.5) to make connection. On request for greater distance between the controller and the ventilation unit, the cable should be replaced/extended (maximum 25 m). The controller is installed by a technician of a specialised electrical company. **Caution:**

CPB	Wall mounting	Option to fit on a junction box

4.7.3 WB1 Touch controller

The WB1 Touch type for the complete control and programming of the unit with the **Web and Web CF control type – optional**. It is supplied to be mounted on the wall. An option to install on a standard junction box with a spacing of holes 68 mm. It is advisable to install the controller on the wall at a height 1.3 to 1.5 m in an easily accessible, illuminated and dry place; it must not be installed in close proximity to heating units and in close proximity to radiating surfaces – it includes an internal thermostat. Use a shielded cable (SYKFY 2x2x0.5) to make connection. On request for greater distance between the controller and the ventilation unit, the cable should be replaced/extended (maximum 25 m). The controller is installed by a technician of a specialised electrotechnical company.

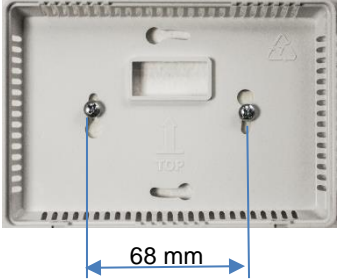
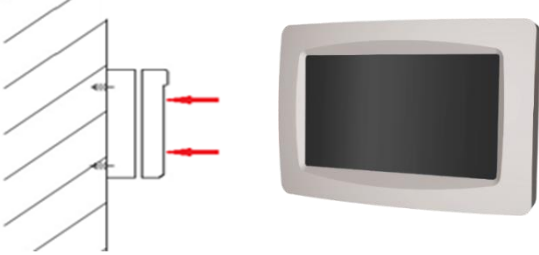
 <p>Push here</p>	 <p>Snap the box together only in one direction</p>
<p>Step 1: before installation, dismantle the controller and detach the rear side from the front side.</p>	<p>Step 2: attach the rear side of the box to the appropriate points on the wall and fasten by means of screws.</p>
 <p>68 mm</p>	
<p>Step 3: snap the front side with a display to the attached rear side.</p>	<p>Step 4: controller mounted on the wall.</p>

4.74 **WB2 controller**

The WB2 type for ventilation and supply air temperature control of the unit with the **Web and Web CF control type – optional**. It is supplied to be mounted on the wall. An option to install on a standard junction box with a spacing of holes 68 mm. It is advisable to install the controller on the wall at a height 1.3 to 1.5 m in an easily accessible, illuminated and dry place; it must not be installed in close proximity to heating units and in close proximity to radiating surfaces – it includes an internal thermostat. Use a shielded cable (SYKFY 5x2x0.5) to make connection. On request for greater distance between the controller and the ventilation unit, the cable should be replaced/extended (maximum 25 m). The controller is installed by a technician of a specialised electrotechnical company.

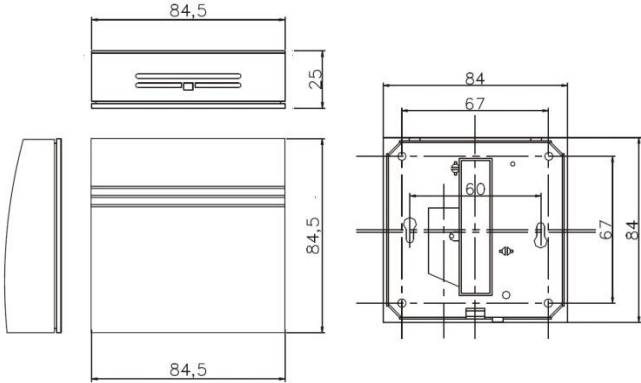
	
<p>CP10RT</p>	<p>Wall mounting</p>

4.8 Handedness change for DV170/DV370/DV570 units

Caution: Disconnect the power supply from the ventilation unit before installation or removal of the controller. Handling of energised controller could result in electric shock or in damage to the controller. It applies to all types of controllers.



4.81 **Handedness change for units with Web control system**

Change in the left / right hand position is carried out when the unit is being activated only by SW setting of the supply fan as motor M1/M2, see servicing documentation.

4.82 **Handedness change for units with Basic control system**

Change in the unit orientation is carried out only by changing the factory position of two temperature thermostats and by reconnecting the cables. Both sensors are mirror-moved to the other side of the unit:

- T1 – fresh air inlet sensor – by-pass thermostat (close to filter - red terminals)
- T2 – exhaust air outlet sensor – thermostat against anti-freeze protection (close to fan M1 - blue terminals)

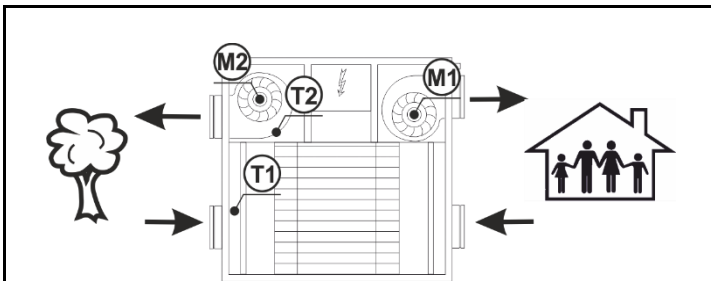

Installation of T1 and T2 sensors – basic factory position

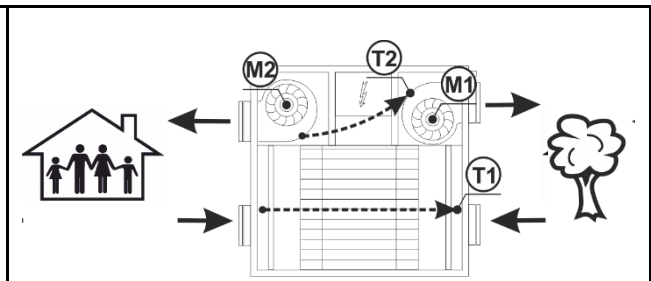

New positions of T1 and T2 sensors after movement

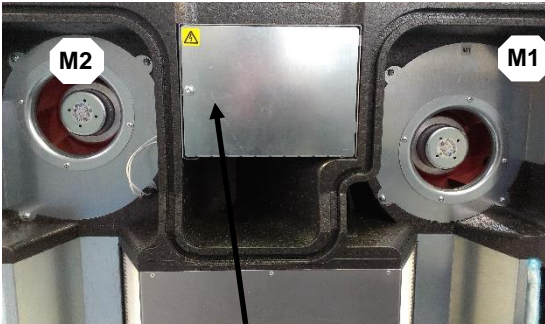

Disconnect the unit from the power supply!
Remove the screw from the control system cover
Remove the control system housing

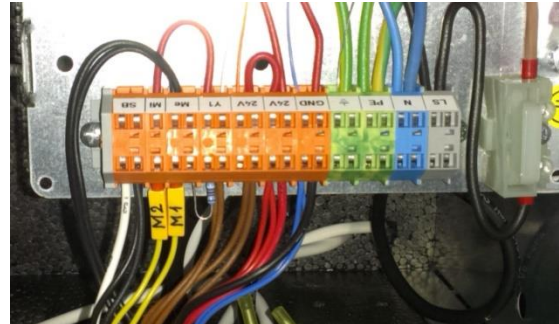

Change the position of M1 and M2 cables.
Factory connection:
M1 → terminal Me, M2 → terminal Mi

Connection following a change in the orientation:
M1 → terminal Mi, M2 → terminal Me



Remove the air filters
Remove the T1 sensor from the original position
Pull the sensors out of the terminals (red colour)



Place the sensor in a new position
Screw into the guide
Plug into the terminals (polarity does not matter)

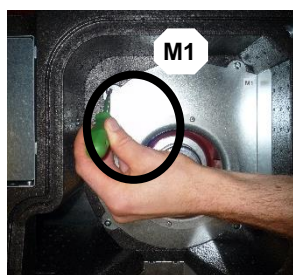

Pull the sensor cables out of the terminals (blue colour)
Remove the T2 sensor from the original position
Remove the screw from the fan M1

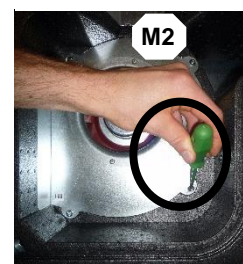
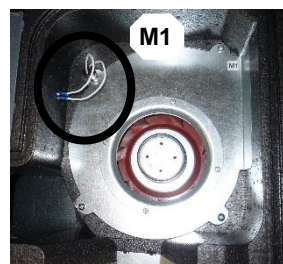

Place the sensor in a new position
Screw in the T2 sensor
Plug into the terminals (polarity does not matter)
Screw into the fan M2

5. Measurement and control, wiring



All interventions in the control system (change/replacement of sensors, checking of connection of the individual parts, etc.) shall be carried out without voltage (after disconnection from the power supply)!

5.1 Web control system with WB1 Touch controller

The WB1Touch controller can be connected to Duplexvent units fitted with an Web control board. The WB1 Touch provides full control for these units, i.e. service parameter settings (password protected) as well as user settings. It has a manual mode, allowing the user to choose directly the operating mode of the unit, and a weekly mode controlling the unit according to a weekly program. The software version is also shown in the user setting of the controller (6.8).

5.11 Connecting the controller to the unit

For the controller's electrical connection follow the wiring diagram located in the lid of the AHU's cabinet.

If there more controllers connected, they must be in a series as shown below.



Note:

According to the diagram up to four controllers can be connected to a unit with Web controls. The last controller on the bus bar must have an activated termination resistor – jumper short circuit, see below

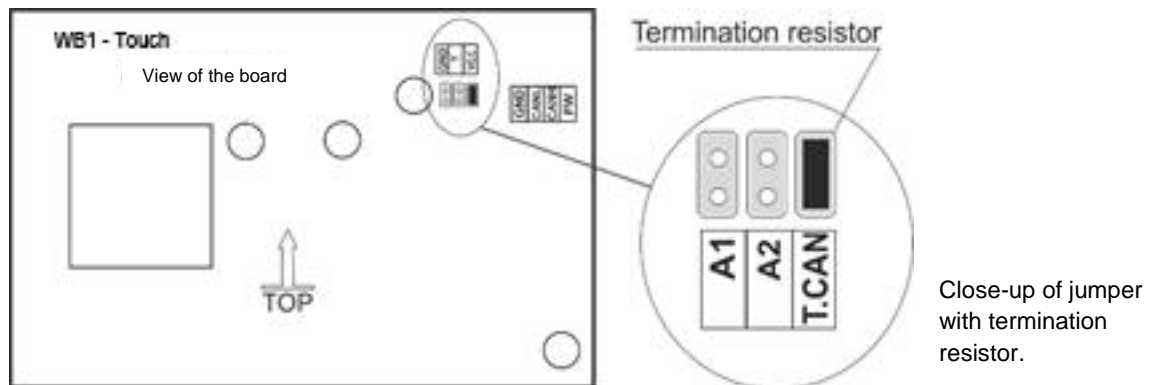

The back of the controller board has jumpers at designated points.

T.CAN – A termination resistor jumper; the jumper must be fitted on the last controller in line.

A1 – 1. Controller addressing jumper

A2 – 2. Controller addressing jumper

The jumpers of each controller on the same bus bar must have a different address.

Table 1 shows controller connection options. When more controllers are installed, their addressing must be different. The last controller in the series must be terminated with a T.CAN jumper.

Number of controllers connected	A1	A2	T.CAN
1	0	0	✓
1	0	0	0
2	✓	0	✓
1	0	0	0
2	✓	0	0
3	0	✓	✓
1	0	0	0
2	✓	0	0
3	0	✓	0
4	✓	✓	✓

0..... Unconnected jumper

✓ Connected jumper

5.12 **Controller description and functions**

Turn on the light of a connected controller by clicking on the dark screen. The WB1Touch controller can be connected to Duplexvent units fitted with Web control board. The WB1Touch provides full control for these units, i.e. service parameter settings, protected by a password..

The controller enables::

- - A manual mode, allowing the user to choose directly the operating mode of the unit
- - A weekly mode to control the unit according to a weekly program

5.13 **Starting the display**

After switching the WB1 Touch on, a starting screen appears with additional information on the status of communication with the unit.

Text/Status	Controller operation
Waiting for status	The launch application is waiting for the controller's executing part to start up; this takes approximately 10s
Loading application	Loading of the application in the controller, which takes up to 10s. The controller screen may darken for several seconds.
Downloading application	An updated version of the application is being downloaded from the control board; this may take approximately 4 minutes.
Waiting for connection	The controller is waiting for communication with the control board; if this takes more than 3 minutes, the screen switches to "Communication Error"
Main screen appears, but data are "0"	The controller's application has loaded properly, but communication with AHU controls is not available yet. This status may appear after switching the unit's power supply when the control module application has not been launched yet after starting power supply. It should not last longer than 1 minute.
Communication error	Communication between the controller and the unit has not been established. A new attempt to connect is made after restarting power supply.

Main screen:

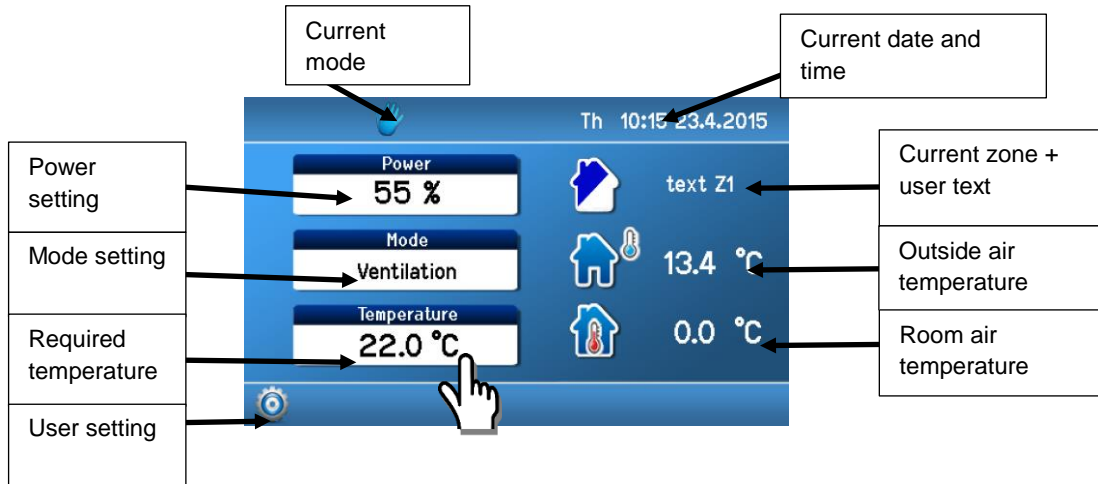

To adjust parameters on the main screen, click on a parameter

5.14 Symbols and their meanings

- Required parameter setting mode symbols; one of the symbols is always displayed.





5.15 Symbols on the main screen

Group 1		Manual control of the unit
Group 2	 	Unit control according to a weekly program Temporary manual change of the weekly program
Group 3	 	Party/Holiday mode active Bank holiday mode active
Group 4	 	Symbol indicates heating Symbol indicates cooling
Group 5	 	Active alarm symbol (yellow) 📖 8 Active notification symbol (blue) 📖 8

5.16 Navigation symbols

	Clicking returns the screen one level back
	Clicking returns the screen to the main screen
	Current language icon; clicking on the flag shows the page with language settings

5.17 Symbols fixed on the main screen

 13,9 °C	Next to this symbol, outside air temperature T-ODA is shown
 24,2 °C	
 23,7 °C	If extraction / room temperature control is used, interior temperature T-IDA is shown (room or extraction air temperature)
	If supply air temperature control is used, supply air temperature T-SUP is shown
	

5.18 "Power" block

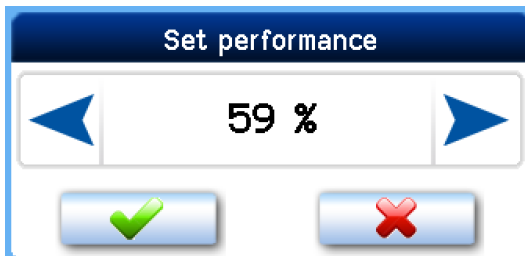

It shows the unit's power level current at the time in % or m3/h according to the configuration of the unit. The current power level value may not correspond to the value set manually or in the weekly program. If that is the case, the power level required is generated by a closed input or a connected sensor such as that of CO2 concentration.

5.19 "Mode" block

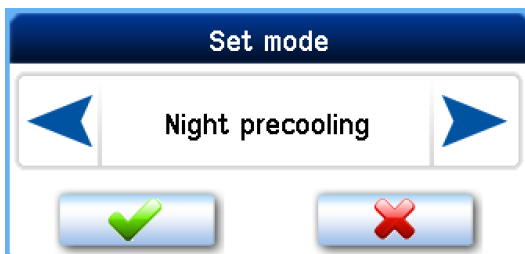

It shows a mode current at the time, with options as provided by the unit's configuration. The current mode parameter may not correspond to the parameter set manually or in the weekly program. If that is the case, the power level required is generated by a closed input D1 - D4 or one of the inputs IN1 - INk4/2..

5.110 List of modes (defined by the type and configuration of the unit)

OFF – The unit is switched off.

Automatic - The unit is in "OFF" mode. It is started by the periodic ventilation timer or when input status changes (Dn, INk).

Ventilation – The unit is ventilating at a power level set or higher as set by an external input which is active.

Night pre-cooling – The unit is in "OFF" mode. It starts ventilation if temperature in the room is higher than required and outside air temperature is lower than room temperature. The night pre-cooling function requires that the T-ETA > Tp condition be met.

Balanced - M-SUP and M-ETA fan control according to the power level required and the value of the required M-SUP correction parameter. It depends on the correction setting, which remains unchanged.

Circulation – The unit is circulating air in the room. It heats and cools as required..

5.111 “Temperature“ block “

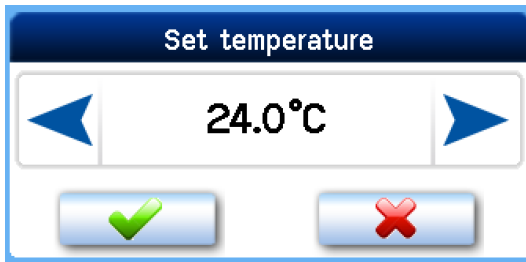

It displays temperature in °C current at the time. The current temperature level value may not correspond to the value set manually or in the weekly program. If that is the case, the temperature required is generated by a closed input D1 – D4 and parameters set for one of these inputs if a specific temperature for Dn inputs is set. .

5.112 “Zone“ block

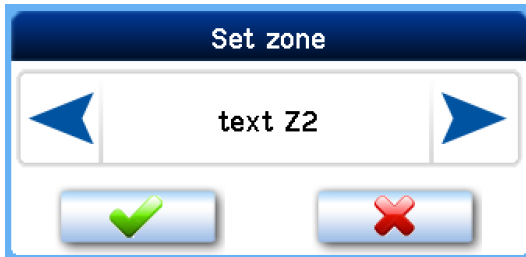

It shows a ventilation zone required at the time

Zone ventilation is set by clicking on the Zone icon  on the main screen.

The zone requirement current at the time may not correspond to the value set manually or in the weekly program. If that is the case, the zone requirement is generated by a closed input D1 – D4 and parameters set for one of these inputs.

Note

Zone texts can be set, for more information see 6.6. The initial zone description setting is: Text Z1 / Text Z2 / Text Z1+Z2.

Active ventilation zone symbols with captions:



5.113 User settings

By pressing the button  on the main screen user setting options are displayed on the main screen.

5.114 Parameters

The “Parameters” options allow choosing operating parameters, setting the HS/NHS parameters and setting automatic switching between HS and NHS.

5.115 Control

“Manual” – The operating modes of the unit are selected directly by the user.

“Weekly program” – The unit is controlled according to the weekly program

5.116 Switching between HS/NHS

This allows setting the heating or non-heating season or automatic switching between them.

“NO” – The IN1 input (analogue control input) is always effective.

“HS” – Heating season; supply air heating or room heating is allowed.

“NHS” – Non-heating season; supply air cooling or room cooling is allowed.

“T ODA-” – Automatic switching between HS/NHS based on outside temperature. The switch-over value is set by parameter “Temperature HS/NHS” (6.1.3). If outside temperature is higher than Temperature HS/NHS, the Non-heating season is selected automatically. If outside temperature is lower than Temperature HS/NHS, the Heating season is selected automatically.

“T ODA+” – Automatic switching between HS/NHS based on outside temperature and a ratio between required and room temperatures. The switch-over value is set by parameter “Temperature HS/NHS”.

Note

- If outside temperature is higher than Temperature HS/NHS , the Non-heating season is selected automatically.
- If outside temperature is lower than Temperature HS/NHS and at the same time room temperature is higher than the required temperature by more than 5°C, the NHS remains active until outside temperature does not drop below 0°C.
- If outside temperature is lower than 0°C, the HS is always set automatically

5.117 HS/NHS temperature

An outside air temperature level for automatic switching between the HS and NHS.

5.118 Current season

Indication of a season currently selected – HS or NHS. This parameter is not one for setting but providing information only

5.119 Control settings

Settings in this chapter describe the conditions of ventilation operation by the AHU.

5.120 Blocking input IN1 (No/HS /NHS)

The effect of input IN1 on the ventilation unit's operation may be limited according to the season currently selected at the time.

„No“ – The IN1 input is always effective.

„NHS“ – The effect of input IN1 on the unit's operation is blocked during the Non-heating season.

„HS“ – The effect of the IN1 input on the unit's operation is blocked during the Heating season.

5.121 Blocking input IN2 (No/HS /NHS)

The effect of analogue input IN2 on the ventilation unit's operation may be limited according to the season currently selected at the time.

„No“ – The IN2 input is always effective.

„NHS“ – The effect of input IN2 on the unit's operation is blocked during the Non-heating season.

„HS“ – The effect of the IN2 input on the unit's operation is blocked during the Heating season..

5.122 Heating hysteresis

To set a temperature difference compared to the temperature required to start heating. The setting range is between 0.1 °C and 5°C (0.1°C steps).

5.123 Cooling hysteresis

To set a temperature difference compared to the temperature required to start cooling. The setting range is between 0.1 °C and 5°C (0.1°C steps).

5.124 Bank holidays

Settings as per user requirements; up to sixteen different dates can be set.

Steps for bank holiday settings:

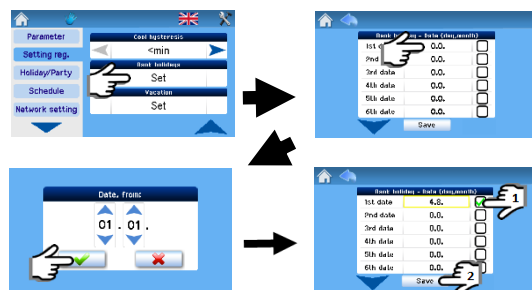

Note : The AHU unit is controlled according to bank holiday settings when:

- The unit is in weekly program control mode
- There is a bank or school holiday on the day current at the time
- The bank holiday (school holiday) date is ticked in the holiday settings

5.125 School holidays

Settings as per user requirements; up to four different holiday periods can be set.

Steps for school holiday settings:

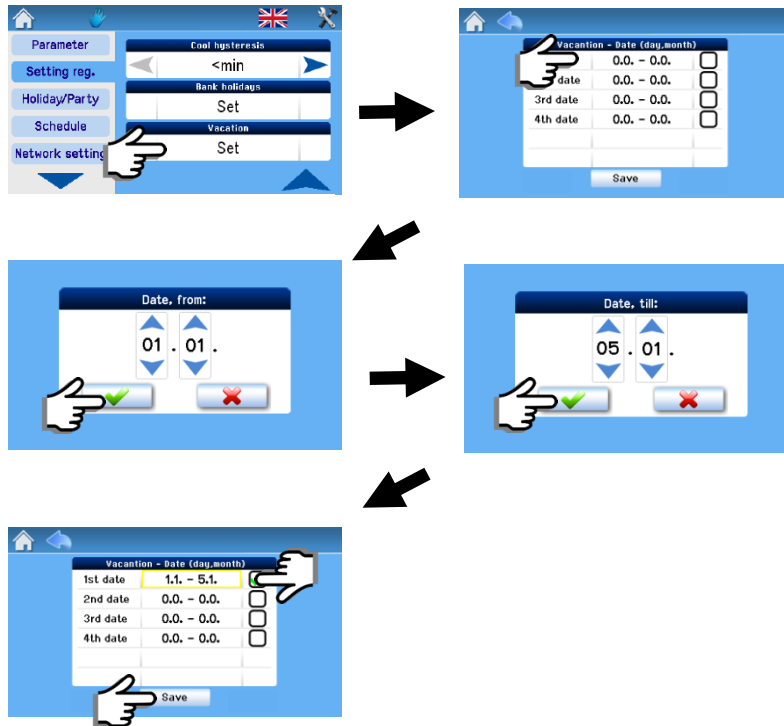

5.126 Holiday/Party

This is a mode set for a limited period of time during which the unit's operation is other than in regular modes, such as when the unit is normally run according to the weekly program and should be switched temporarily to economy mode for example for a week when there is no occupancy in the house.

When the parameters set for the Holiday/Party function have been stored, the unit is activated for operation according to these parameters; these cannot be subsequently modified or the unit's operation mode changed until the period set expires or the Holiday/Party function is deactivated manually (Deactivation button).

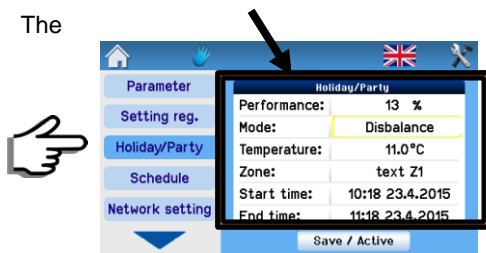

settings below apply when the Holiday/Party mode has been activated “.

Power: For Power settings.

Mode: For Mode settings 5.19. .

Temperature: For Temperature settings. 5.111

Zone: For Zone settings see 5.112

Start time: The starting time of the mode may be delayed; the Holiday/Party mode starts according to the start time set.

End time: The Holiday/Party mode ends according to the end time set.

“Store/Activate” mode button: It serves for storing the parameters set. The mode is activated and deactivated according to the start and end times set. (After pressing, this button changes to the “Deactivate” button).

5.127 Weekly program setting

The weekly program is set separately for the heating and non-heating season.

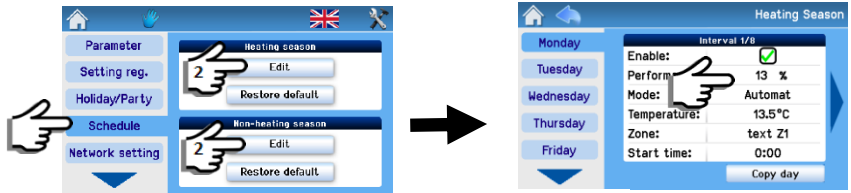

5.128 Day copying

Settings may be copied between days as shown below:

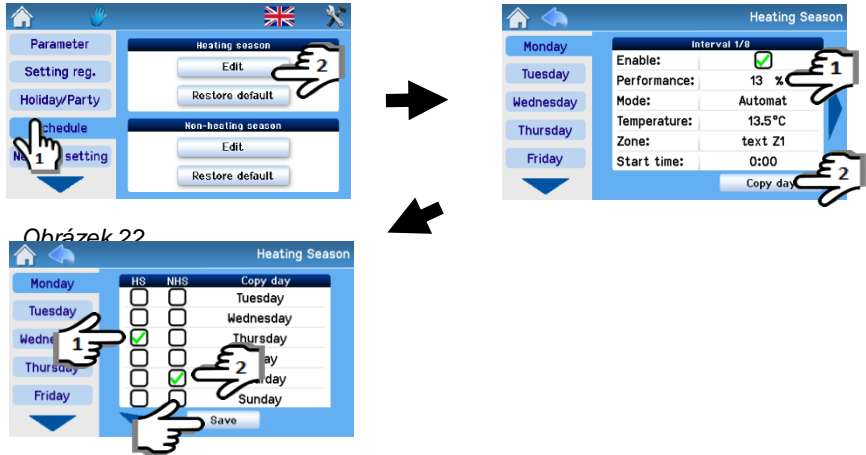

Example of copying: When copying, first check Wednesday in HS and then Thursday in NHS , thereby copying all settings for Wednesday in HS to Thursday in NHS.

Settings for each season provide eight intervals for each day of the week and separate settings for Bank holidays and School holidays. Each interval allows setting all operating parameters of the AHU and the start time of the interval.

Unless the first interval of a given day starts at 00:00, the unit continues to run with parameters set by the last interval of the previous day until the first interval start time..

Note:

Use the arrows and to move between all eight intervals

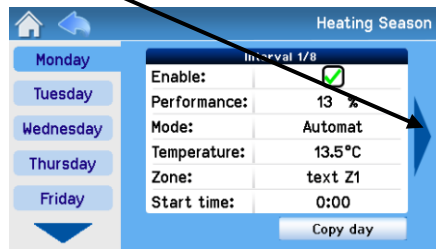

The weekly program allows copying and pasting the settings of a given day as follows:

- Into each day of the week
- Into selected days
- Into Bank holidays / School holidays
- Into Heating and Non-heating season days

5.129 Network setting

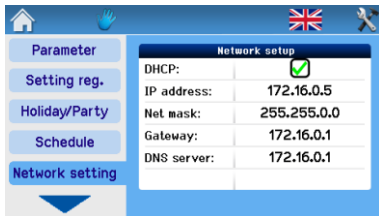

DHCP: When checked, the network is automatically set from the internet; if not checked, the network must be set manually

Note: The “Save” button records the values set and also immediately restarts with new values.

5.130 Texts

The “Texts” parameter is used for changing adjustable texts as required.

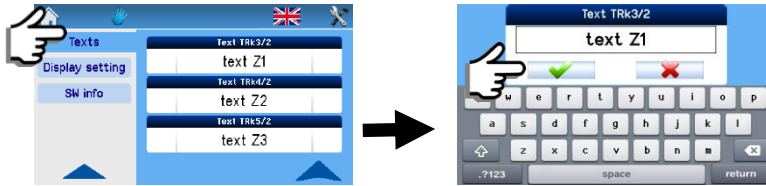

Note



The texts can be adjusted as required and are the same as those for setting from the web.

The respective text is shown in the “Mode” box of the unit switches to the mode according to this input.

D1 - D4, IN1, IN2, Zone 1, Zone 2, Zone 1+2, INK1 - INK4, T

5.131 Display settings

In this section you can set the basic parameters of the display:

Backlight setting The display backlight is changed using the setting arrows  

Internet time sync Time sync with the internet is done by checking this option as shown in  ; the update is done immediately.

Time and date setting The date and time are set by clicking as shown in 

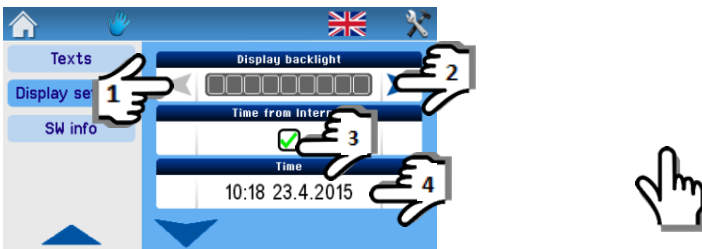

V In the event of a power failure and load the wrong time data, it is necessary to replace the internal battery onboard the RD-int

- Type internal power battery CR 2032, placing the control module, board RD-int.

- Must be replaced by a service technician.



5.132 Time zone setting

An option to switch automatically between the summer and standard time.

5.133 Daylight saving time (summer time)

An option to switch automatically between the summer and standard time.

5.134 **SW information (unit type, configuration, specifications, version)**

Information on the type of the unit, its manufacturing number and the version of the control software.



5.135 **Filter replacement indication**

In some units, the “Filter replacement” notification is also shown by the button for filter replacement confirmation (by pressing this button the date of subsequent filter replacement is saved).

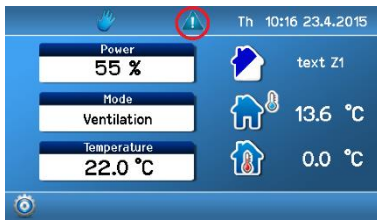

5.136 **Table of alarms and notifications**

The messages shown in the table below provide information on irregular or unexpected events in the AHU system

Table of alarms (yellow triangle) 

Message	Meaning	What to do?
Room temperature sensor	Failure of the room temperature sensor connected to the CP-Touch controller.	Contact a service technician.
TEa temperature sensor	Communication breakdown or failure of the TEa temperature sensor.	Contact a service technician.
TEb temperature sensor	Communication breakdown or failure of the TEb temperature sensor.	Contact a service technician.
Heat recovery exchanger freezing	Frost depositing inside the heat recovery exchanger.	The air extracted from the building is likely to be very humid and the outside temperature is low. This condition usually lasts for several minutes and the unit goes back to normal operation after the heat recovery exchanger has been defrosted.
Temperature sensor downstream TA2 external heater	Communication breakdown or failure of the temperature sensor downstream the warm water or electric heater.	Contact a service technician.
1st frost protection	Temperature downstream the heater is lower than 9°C.	Check the warm water supply. AHU warm water supply opens.
2nd frost protection	Temperature downstream the heater is lower than 7°C.	Same as for 1st frost protection. Contact a service technician.

STOP circuit active	The emergency stop contact is opened.	The stop contact has been activated by a fire or other safety system; check its status.
Temperature sensor TU1	Communication breakdown or failure of the TU1 fan temperature sensor in the unit.	Contact a service technician.
Temperature sensor TU2	Communication breakdown or failure of the TU2 fan temperature sensor in the unit.	Contact a service technician.
Orientation stings(only applies to DV170/DV370/DV570)	The unit's orientation is not set, i.e. it is not determined which fan is the supply fan and which is the extraction one.	This parameter blocks the operation of the unit and must be set in the service menu. Contact a service technician.
Heater setting	The heater type is not set (water or electrical).	This parameter blocks the operation of the unit and must be set in the service menu. Contact a service technician.
Manometer failure	If the unit is fitted with air flow rate gauges, one of them does not measure correctly or is faulty.	Contact a service technician.
Unbalanced flow rate	The flow rate through the unit is out of balance, the fans do not work as per settings.	Contact a service technician.
AHU overheat	One of the temperature sensors has detected a temperature higher than 77°C.	Disconnect the unit from power supply and, if there is no risk of overheating in the room (fire etc.), reconnect it.

Table of (blue triangle) 

Clogged filter	The filters in the unit are clogged and not working properly.	The filters in the unit must be replaced.
Heat recovery exchanger defrosting		
	Frost deposits in the heat recovery exchanger; the unit is not recovering the heat but defrosting.	The air extracted from the building is likely to be very humid and the outside temperature is low. This condition usually lasts for several minutes and the unit goes back to normal operation after the heat recovery exchanger has been defrosted.
Insufficient heating capacity of Heater 1		
	The heating capacity of the unit's heater is not sufficient.	Check the status of primary heating. The unit has switched to heating from its back-up source.
High tariff		
	The unit does not start the electric heater due to high electricity prices.	Power supply in a high tariff. Electrical heating is blocked.

5.137 **Forgetful operator**

After the ventilation period set has expired, the command on the D1-D4 input is deactivated. This function limits the duration of the AHU running.

5.138 **Bypass dampers**

Dampers for bypassing the heat recovery exchanger. Duplexvent heat recovery units are optionally fitted with a heat recovery exchanger bypass. The damper can be used e.g. for pre-cooling buildings by air from the outside at night in the summer or cooling in the transitional period. This saves costs of cooling.

The bypass damper is primarily controlled by setting the required temperature T_p and cannot be controlled manually.

5.2 Web control system with WB2 controller

The controller is used to control the mechanical performance fan, the choice of supply air temperature, turn on / off devices and failure signalling. Connecting see chapter 4. The controller can be combined with the controller WB1 Touch or internet control.

Description:

- Performance ventilation adjustable knob in the range 0; 10-100%
- option button on / off switch (mechanical lock)
- reheating the supply air closes the second power selector raises the temperature in the range of 15 - 25 ° C
- operation of the heater replaced signalled green light
- Various LED is lit to indicate device status

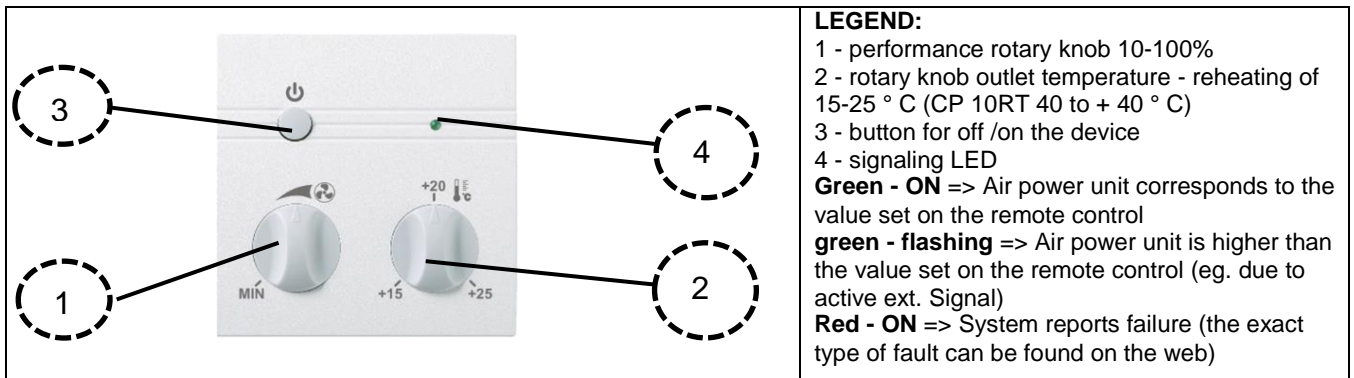

5.3 Basic control system with BC1 controller

The equipment operated using a BC1 controller with touch-screen display.

Description of functions:

- Controls are divided into user and servicing sections (accessible by service technicians only).
- Ventilation capacity can be set in a range of 0-100 %.
- Options to switch on the air reheater, air preheater and shut-off damper servo drive.
- Control in manual mode or via separate weekly programs for ventilation capacity and air reheating.
- Additional operating mode "Party" (a temporary increase in capacity) and "Holiday" (temporary ventilation switch-off).
- An option to control ventilation automatically by external sensors (air quality, CO₂, relative humidity etc.).
- An option to start increased ventilation using external switches, e.g. in the bathroom or toilet.
- An option to limit maximum and minimum ventilation capacity.
- Displays the current room temperature and operating mode.
- Alerts to the need for air filter replacement.

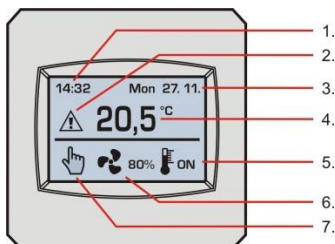

Display:

1. Time
2. Alerts (e.g. the need for filter replacement)
3. Date
4. Current room temperature
5. Air reheating indication (if the system includes a reheater)
6. Ventilation capacity setting in %
7. Selected operating mode

Description of controls:

Short press – general controls and parameter settings

- Long press (3 s) of the ventilation capacity symbol – quick operation on / off
- Long press (5 s) at the top of the display – entering the service menu







5.31 Performance settings

When a BC1 controller is used for controlling and programming, the capacity is shown (displayed) in per cents of the maximum. The table shows approximate air flow rates (m³/h); they may vary depending on the duct network.

Duplexvent	OFF	0%	10%	20%	30%	40%	50%	60%	70%	80%	90%	100%
DV170	OFF	Unit responds to sensors and external inputs	20	40	55	70	100	110	135	150	165	180
DV370			45	80	120	180	240	270	290	310	340	370
DV570			60	110	150	210	290	320	380	430	500	570
DV280			25	40	60	80	110	140	160	190	240	285
DV380			40	70	100	160	190	220	260	300	340	365
DV580			65	120	160	220	300	330	390	440	510	565

5.32 Unit's operating modes

The HVAC unit works according to settings made by the controller, external inputs from the bathroom, toilet or kitchen and air quality sensors in following modes:

Displayed mode	Description	Suitable application <i>(data may vary depending on national regulations)</i>
	"Manual mode" – a general ventilation mode, with ventilation provided by the unit according to current settings.	Continuous ventilation during occupancy, with the capacity set at outside temperatures as follows: <ul style="list-style-type: none"> • Above approx. -5°C to approx. 25 m³/h/person, i.e. for 4 persons 100 m³/h, with 70 m³/h set at night. • Below approx. -5°C to approx. 20 m³/h/person, i.e. for 4 persons 80 m³/h, with 50 m³/h set at night.
	"Weekly program" – a general ventilation mode, with a required rate of ventilation provided by the unit according to schedule parameters.	
	"Automatic mode" – the capacity of ventilation is set by an active external input, i.e. the user's request from the bathroom / toilet / kitchen or according to an air quality, CO ₂ , humidity etc., if installed.	The unit switches over to these modes automatically if current ventilation demand exceeds the capacity set in manual mode or a weekly program.
	"Ventilation run-down time" – a temporary ventilation mode which stops automatically after the pre-set time has elapsed.	The unit switches over to this mode automatically after a request from the bathroom / toilet / kitchen has expired (if a run-down time is set).
	The "Party" mode is temporary and stops according to the pre-set time.	A temporary mode for less frequent use of the building, such as a party attended by a large number of people (a request for higher ventilation capacity).
	The "Holiday" mode is temporary and stops according to the pre-set date and time; after that a weekly program is activated automatically.	A temporary mode for less frequent use of the building, such as a holiday (a unit deactivation request).

5.33 Description of controls

The operating modes of the unit can be changed by selecting functions and parameters in respective menus using the touch-screen display. The requested option (changing the function or parameter) in each menu must be confirmed by pressing the "OK" symbol or a symbol of "arrows" to move to the next menu. If you press the symbol "Esc" option is ignored and the system automatically returns to basic (Information) menu.

Note – in idle (display) state is the touch screen BC1 glazed over, at the first touch automatically activates the backlight display, next touch can change particular functions (see description below).

5.34 Basic menu

- Operating mode selection
- Ventilation capacity selection or operation start / end

- Switching on air reheating (if a reheater is installed in the system)

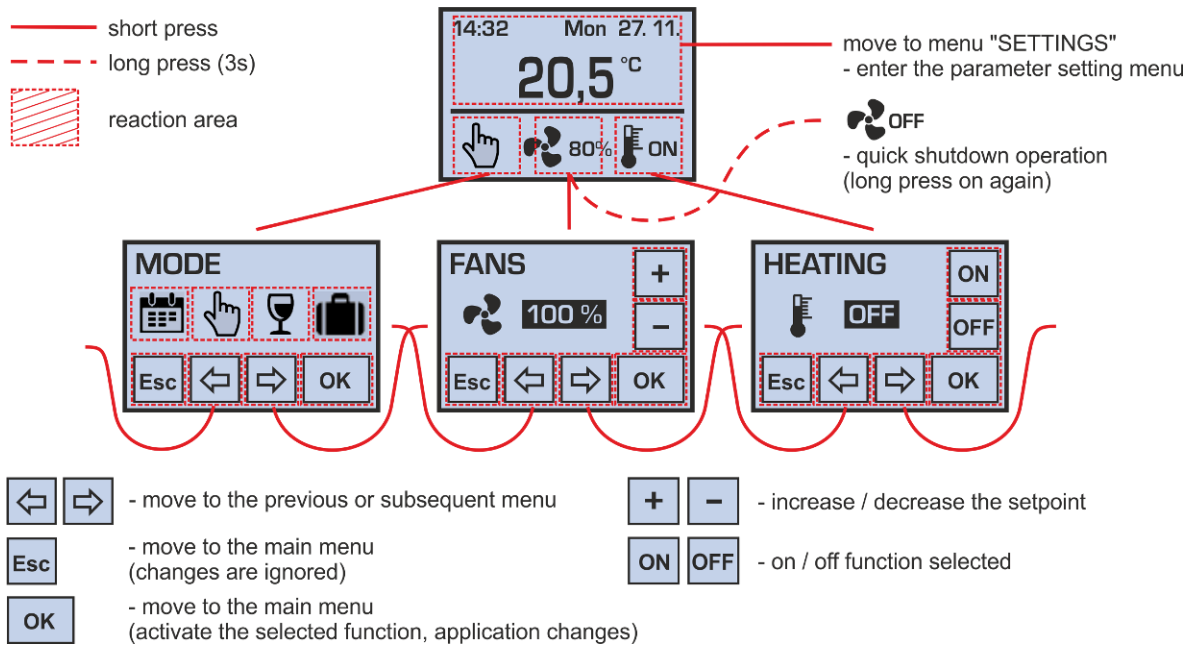

If operation is ended by setting ventilation capacity to "OFF", the unit does not respond to an external request, i.e. switches in the bathroom / toilet / kitchen and the air quality sensor are ignored).

If power is set to "0 %", then the fans are stopped and the unit is not ventilating. In contrast to the "OFF" state, in this "0 %" mode is still active automatic start according to external switches.

Note – if none of buttons in submenus is pushed for a long period of time, then the BC1 controller automatically switches to the main menu.

5.35 "MODE" menu (operating mode)

- Selecting a weekly program / manual mode / Party mode / Holiday mode

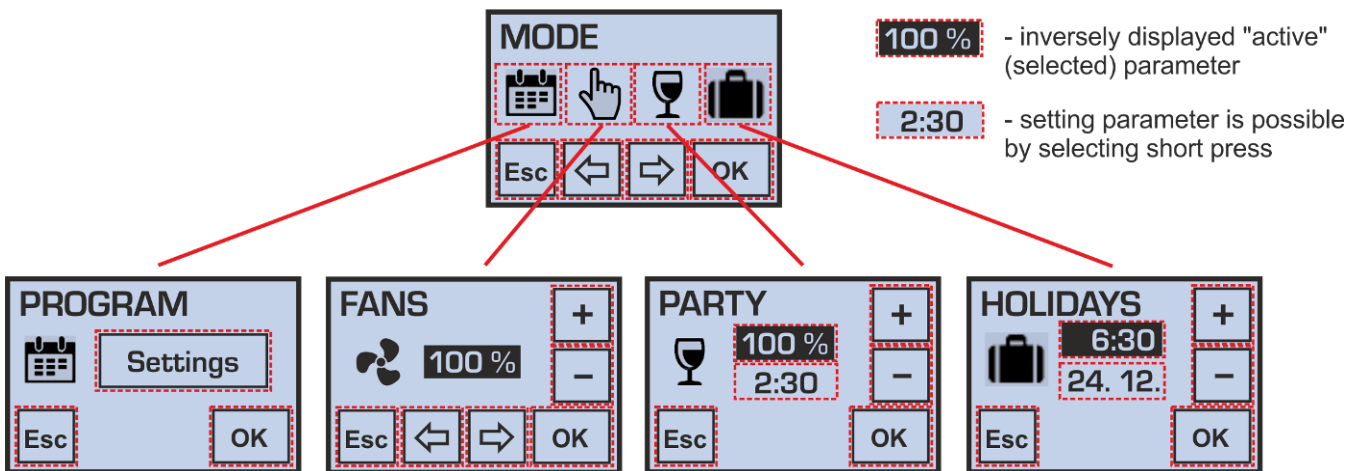

If more than one parameter is shown in the menu, you can switch between these by a short press; a parameter can be set by pressing "+" and "-" repeatedly (setting can be faster if you press and hold the symbol).

5.36 Menu „PROGRAM“ (weekly program)

- Setting a weekly program (time schedule) for ventilation capacity
- Setting a weekly program for starting air reheat

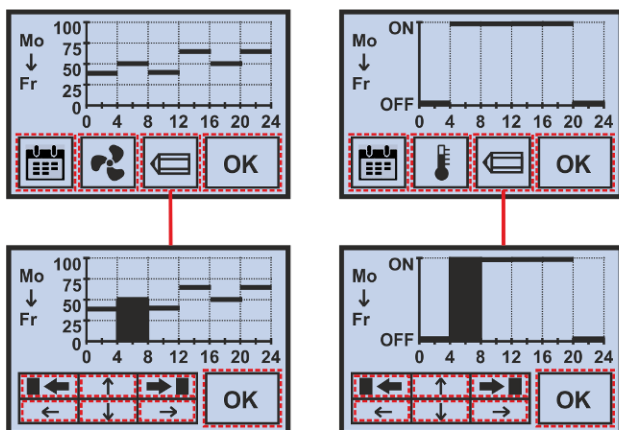

schedule power ventilation

schedule reheating the air

- switching option period (Mo-Su / Mo-Fr / Sa-Su / Mo / Tu / We / Th / Fr / Sa / Su)
- weekly switching program performance ventilation / air reheating
- treatment selected weekly program
- confirm the changes and return
- selection intervals (intervals of 6)
- setting ventilation performance of 10% or switching reheating (ON / OFF)
- setting the start time interval after 15 min. (except for the first interval)

Changes made in a weekly program for a selected period of **Mon-Sun / Mon-Fri / Sat-Sun** are effected in all selected days together, while changes made for a period of **Mon / Tue / Wed / Thu / Fri / Sat / Sun** are effected only for the specific selected day.

Warning:

If one or more days of the week have been set individually, parameters for these individual days will be rewritten according to the new settings when a period of Mon-Sun / Mon-Fri / Sat-Sun is subsequently selected in adjustment mode (the pencil symbol).

5.37 “PARTY“ and“ HOLIDAY” menu (temporary operating modes)

- Setting the required ventilation capacity of the “Party” mode in a range of 20 – 100 %
- Setting the duration of the “Party” mode in a range between 10 minutes and 5 hours
- Setting the time and date of ending the “Holiday” mode

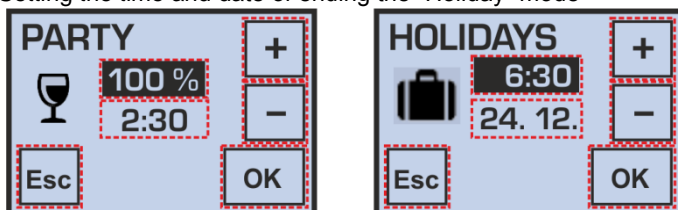

After the “Party” mode has finished, the unit automatically returns to the operating mode selected before that; when the “Holiday” mode has finished, the unit automatically switches over to operating mode which is current according to a weekly program.

Note – The “Party” and “Holiday” modes can be stopped early by selecting another operating mode.

5.38 “REHEAT” menu (air reheat)

- Starting air reheat in manual mode

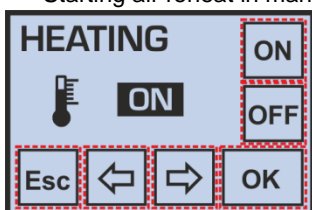

This menu is accessible only provided that an electric or hot-water air reheater is installed (selection in the service menu).

Information on air reheater operation is indicated in the basic menu by symbols and .

Note – Air reheating with an electric heater is only possible with a minimum ventilation capacity of 30 % due to a sufficient air flow rate for cooling the heating elements.

5.39 User system settings

Using directional arrows you can move between individual user menus:

MODE / VENTILATION / REHEAT / FILTER / TIME / SETTINGS

By pressing “OK” in the “SETTINGS” menu other parameter menus become accessible:

WARNING – The wrong parameter settings can have a negative influence on the proper operation of the equipment!

5.310 **“FILTER“ menu**

- Indication of the number of days left until the air filter must be replaced
- Setting the regular filter replacement interval in a range of 30 – 150 days (by 10 day periods)
- Filter replacement confirmation (a new countdown automatically starts after confirmation)

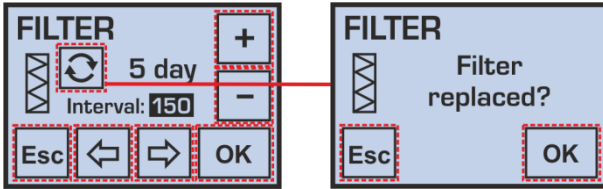

The regular filter replacement interval should be set according to the dust and pollen load of the outdoor environment.

5.311 **“TIME“ menu**

- Date and time setting
- Selecting between 12 and 24 hour time format

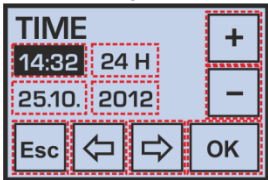

Note – Automatic switching between summer and winter times (DST) is not supported.

5.312 **“INPUT“ menu**

- An option to allow / disallow the increased ventilation capacity function.
Binary input DI1 for connecting external voltage-free switches in bathrooms, toilets or kitchens.
- An option to allow / disallow the function of automatic ventilation control according to the concentration of the quantity being measured.
Analogue input IN1 for connecting an external sensor (sensor “S”) with a 0-10V signal output which can monitor air quality, CO₂ concentration, relative humidity etc.

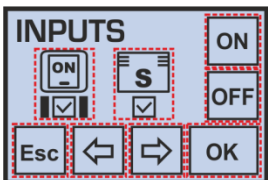

5.313 **“SWITCH“ menu (binary input DI1)**

- Setting ventilation capacity in a range of 10 – 100 % with input DI1 closed
- Setting a function’s start delay time in a range of 0 – 300 s (in 10 second steps)
- Setting a function’s run-down time in a range of 0 – 300 s (in 10 second steps)

If a button is used the start delay time must be set to “0 s” in order for the short press of the button to be accepted, and the run-down time must be set to a non-zero value.

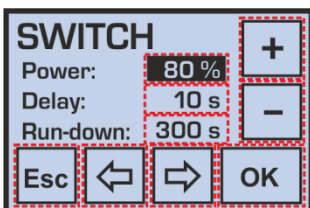

5.314 **“SENSOR“ menu (analogue input IN1)**

- Setting the ventilation curve in relation to the level of the 0-10V signal from an external sensor
This function allows suitably adjusting the unit’s response (ventilation capacity) to a gradual increase in the concentration of the quantity being measured, e.g. for economical or noise reasons.

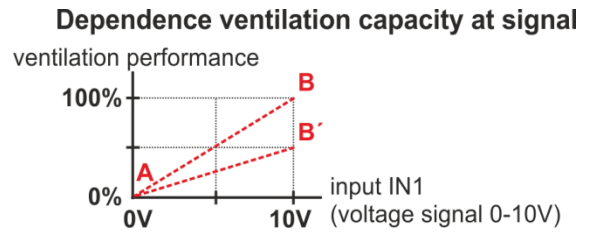
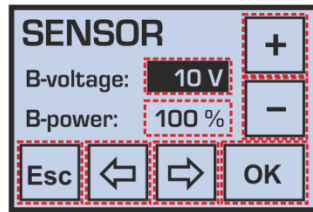
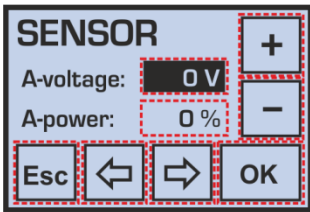

The “inverse” setting of ventilation capacity response to the 0-10V control signal is also supported, i.e. the reverse direction of curve A-B). This function allows connecting also a sensor with a different output voltage range, e.g. 0-5V or 2-10V.

5.315 “LIMIT” menu

- Setting maximum and minimum permitted ventilation capacity limits
- An option to allow / disallow the operation OFF function (ventilation capacity = OFF)

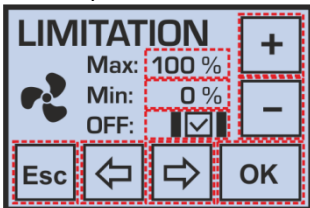

Attention – Settings in the “LIMIT” menu subsequently affect (limit) all operating modes and parameter settings in other user menus.

If the “Min:” parameter is set to a non-zero value, the unit can be switched off only by a long press (3 s) of the ventilation symbol in the basic menu or manually selecting ventilation capacity OFF (if permitted).

5.316 “TEMPERATURE” menu

- Setting the calibration of the internal air temperature in a range of +/- 3°C (in 0.5 °C steps)

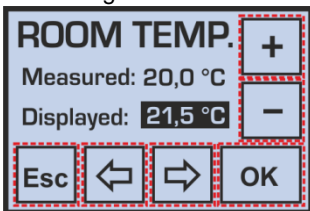

5.317 “DISPLAY” menu

- Setting the display brightness and contrast (recommended values are 70 % and 50 %)

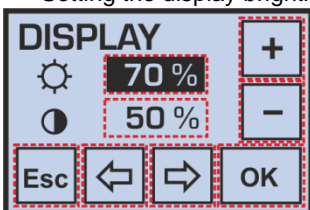

5.318 “LANGUAGE” menu

- Setting the menu language



Note – If the controller has been disconnected from power supply for more than 48 hours, the language is automatically set to English when switched on again.

5.319 Automatic ventilation modes

If there is a discrepancy between the operating mode displayed and the one set manually by the user or a weekly program, then the current operation of the equipment (ventilation capacity) is affected by external request via a contact or analogue input (sensor).

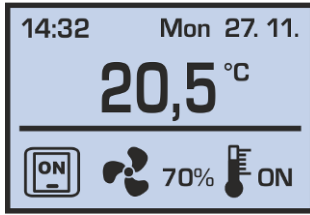

- A request from a switch in the bathroom / toilet / kitchen

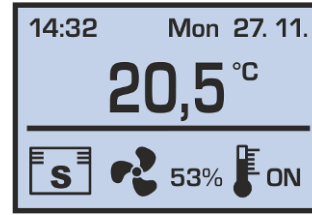

A request from an air quality / CO₂ / relative humidity sensor

5.320 Constant pressure in a supply line

If the unit is operated under constant pressure in the supply line (set in the service menu), then in the "FANS" and "PROGRAM" options are available: OFF / 0% / ☾ / ☀

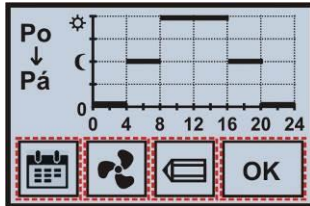

The symbols "sun" and "moon" are the two possible levels of pressure required, ☀ is standard operating (daily) pressure value, ☾ symbolizes the lower pressure value specified for night setback (e.g. due to noise).

This special mode in cooperation with the duct pressure sensor is able to provide automatic control of ventilation capacity by varying the number of ventilated rooms in the building (e.g. central ventilation of residential house)

Note – If a problem occurs during operation, the measurement of pressure in the supply line (e.g. due to pressure sensor failure), it is possible to cancel CS("constant sensor") in the user menu "Inputs" and to deactivate ventilation on constant pressure.

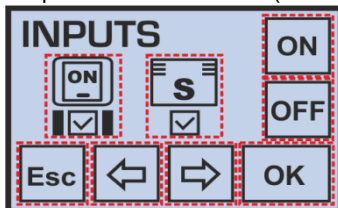

Now you can control the fans performance standard way in manual mode or by setting a weekly program (see description in chapter 5.34, 5.36).

5.321 Warning messages

The controller may display some warning messages during operation which alert to the need for replacing an air filter or flat battery; if the equipment has a defect, a warning message is shown recommending contacting the service department.

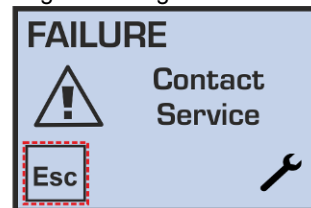
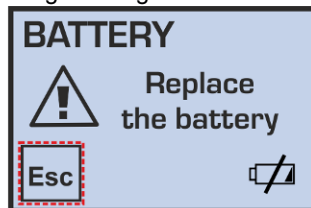

Replacing the controller's battery:

Before replacing the battery disconnect the equipment from power supply!

Then use a tool such as a flat screwdriver to apply pressure onto "lock" on the bottom of the controller and remove the front panel with display. Now it is possible to replace the CR1632 battery and put the two parts of the controller back together. After turning it on it is necessary to set the correct time and date.

5.322 Supply air reheat mode

Only external EPO-PTC series duct electric air heaters, or build-in preheaters/reheater EDO5.CPf, fitted with their own thermostat to set air temperature downstream the heater, can be connected to the equipment.

Up to two such heaters may be connected simultaneously can be connected in the following configuration:

- As a **fresh air pre-heater** (before the unit's inlet, or inside the unit)
The heater works fully automatically without being switching by the user, solely based on the temperature setting; this function (air preheating) only works when the unit is running.
- As a reheater of air supplied into the building (it is located at the unit's outlet, downstream heat recovery)
The heater is started by the user with the controller in manual mode or according to weekly program settings. The reheating function is only active when the unit is running.

Heaters must be fitted and connected according to the wiring diagram and only by a person with a relevant licence.

Before the heater is put into operation, the temperature required downstream the heater must be set on the thermostat:

- For a pre-heater: from 0 °C to +4 °C
- For a reheater: between 10 and 35 °C

5.323 Description of fault messages and their causes

Fault	Description	Possible cause	Troubleshooting
The equipment cannot be started	<ul style="list-style-type: none"> • The equipment remains idle even after the required performance level was selected 	<ul style="list-style-type: none"> • Power supply is not connected 	<ul style="list-style-type: none"> • Connect the equipment to power supply (switch on upstream safety circuit breakers)
		<ul style="list-style-type: none"> • Not found 	<ul style="list-style-type: none"> • Disconnect from power supply and contact a service technician
The equipment is not supplying enough air	<ul style="list-style-type: none"> • The equipment is providing a significantly lower volume of air 	<ul style="list-style-type: none"> • Blocked filter 	<ul style="list-style-type: none"> • Disconnect the equipment from power supply • Replace the filter cloth or cassette • If the equipment has been in operation for more than approx. 4 years, clean the heat recovery exchanger/s
		<ul style="list-style-type: none"> • A mechanical obstacle at fresh air suction or supply air outlets 	<ul style="list-style-type: none"> • Check whether the suction openings of fresh air or supply air outlets are not mechanically covered • Remove any obstacles • Visually and by listening check whether the dampers open properly
		<ul style="list-style-type: none"> • Not found 	<ul style="list-style-type: none"> • Disconnect from power supply and contact a service technician
The equipment is not heating or is heating insufficiently	<ul style="list-style-type: none"> • When the heater has been started, supply air continues to be cold 	<ul style="list-style-type: none"> • The electric heater is not connected to power supply 	<ul style="list-style-type: none"> • Connect the equipment to power supply (switch on upstream safety circuit breakers) – can only be done by an authorized person
		<ul style="list-style-type: none"> • Response of the electric heater's heat protection 	<ul style="list-style-type: none"> • Wait to see if the fault does not sort itself out after approx. 1 hour
		<ul style="list-style-type: none"> • Low maximum capacity of the heater 	<ul style="list-style-type: none"> • Does not constitute a fault (insufficient capacity designed)
		<ul style="list-style-type: none"> • Not found 	<ul style="list-style-type: none"> • Disconnect from power supply and contact a service technician
Water is dripping from the equipment	<ul style="list-style-type: none"> • Water droplets form between the door and body of the equipment during operation 	<ul style="list-style-type: none"> • The condensate drain siphon is insufficiently flooded 	<ul style="list-style-type: none"> • Disconnect the equipment from power supply and flood the condensate drain siphon
		<ul style="list-style-type: none"> • The condensate drain is blocked with dirt 	<ul style="list-style-type: none"> • Disconnect the equipment from power supply and clean the condensate drain including the siphon
		<ul style="list-style-type: none"> • The seal groove is damaged (the fault can be accompanied by a whistling sound caused by air flowing through the gap) 	<ul style="list-style-type: none"> • Disconnect the equipment from power supply and replace the seal
	<ul style="list-style-type: none"> • Water droplets form at the condensate drain connection point 	<ul style="list-style-type: none"> • The condensate drain seal or line is damaged 	<ul style="list-style-type: none"> • Disconnect the equipment from power supply and re-seal the condensate drain
		<ul style="list-style-type: none"> • Not found 	<ul style="list-style-type: none"> • Disconnect from power supply and contact a service technician

5.4 Basic control system with BC2 controller

As standard, the equipment is operated using a simple BC2 controller.

5.41 Description of functions

- Ventilation capacity setting in a range of 0-100 %.
- An option to start the air reheater.
- An option to start the shut-off damper servo drive.
- An automatic ventilation control option according to an external sensor (air quality, CO₂, relative humidity etc.).
- An option to increase ventilation capacity using external switches, e.g. in the bathroom or toilet.
- An option to limit maximum and minimum ventilation capacity.
- Equipment operation indication.

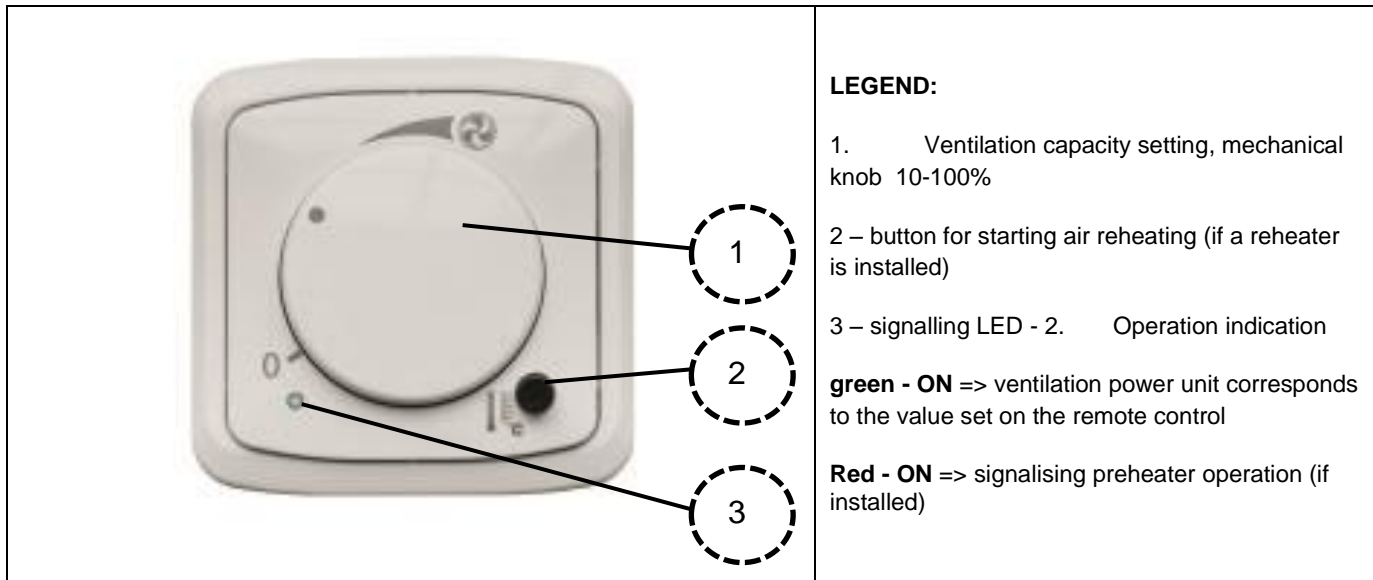

5.42 Performance settings

The same as in the table in chapter 5.31. The HVAC unit operates according to settings by the controller, the closing of external inputs from the bathroom, toilet or kitchen, or an air quality sensor.

5.43 Description of controls

• **Selecting ventilation capacity or starting / stopping operation**

- Rotate the controller to set the required ventilation capacity in a range of 10–100 %.
- Ventilation is stopped by turning the controller anti-clockwise until it reaches the symbol "0" at the end position; however the equipment still responds to external commands – see the chapter 3.3.

• **Starting air reheat**

- The setting applies only provided that an external air heater with its own thermostat is fitted.
- Start air reheat by pressing the button in the right hand bottom corner of the controller next to the thermometer symbol (stop by pressing again)

Note: Air is reheated only when the unit is running. The thermostat temperature is set by the technician in charge of installing the equipment in a range between 15 and 35 °C

5.44 Limiting ventilation capacity

Removing the rotary controller provides access to other control features, the turning of which sets the minimum and maximum ventilation capacity levels (a full range of 0-100 % is set by the manufacturer).

Description:

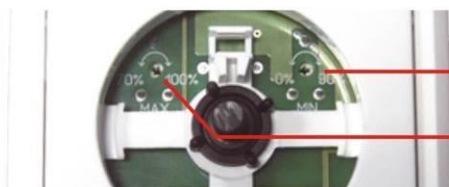

1. Setting of min. ventilation capacity
2. Setting of max. ventilation capacity

6. Commissioning the system, warranty



6.1 Commissioning the system

The Building Regulations 2010, Statutory Instrument Part 9, paragraph 42, imposes a requirement that testing and reporting of mechanical ventilation performance is conducted in accordance with an approved procedure. Compliance with this requirement by an assessed and registered “Competent Person” should follow a “Best Practice” process and adopt air flow measurement, Method A - The Unconditional Method - using a suitable UKAS certified measuring instrument. Generically referred to as a “Zero Pressure Air Flow Meter” or “Powered Flow Meter”. Further information on this method is detailed in NHBC Building Regulations Guidance Note G272a 10/13 and BSRIA “A Guide to Measuring Air Flow Rates” document BG46/2015

6.2 Warranty

Applicable to units installed and used within the United Kingdom. Airflow Developments Ltd guarantees the DV170/DV280/DV370 /DV380/DV570/DV580 Adroit Pro unit for 5 YEARS from date of purchase against faulty material or workmanship. Motors are only covered for 1 YEAR from date of purchase against faulty material or workmanship. In the event of any defective parts being found, Airflow Developments Ltd reserve the right to repair, or at our discretion, replace without charge provided that the unit:

- Has been installed and used in accordance with the fitting and wiring instructions supplied with each unit.
- Has not been connected to an unsuitable electrical supply.
- Has not been subjected to misuse, neglect or damage.
- Has not been modified or repaired by any person not authorised by Airflow Developments Ltd.
- Has been installed in accordance with latest Building Regulations and IEEE wiring regulations by a recognised competent installer.

Airflow Developments Ltd shall not be liable for any loss, injury or other consequential damage, in the event of a failure of the equipment or arising from, or in connection with, the equipment excepting only that nothing in this condition shall be construed as to exclude or restrict liability or negligence. This warranty does not in any way affect any statutory or other consumer rights.

7. Maintenance and Servicing of the Unit

7.1 Maintenance and Servicing of the Unit



Routine maintenance – filter change, unit interior cleaning, heat recovery exchanger cleaning may be carried out by a user's person. For servicing operations associated with replacement or intervention in electrical parts of the unit, use solely servicing technicians, who are involved in a certified network.



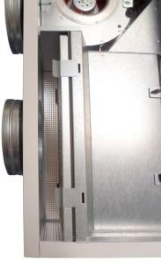
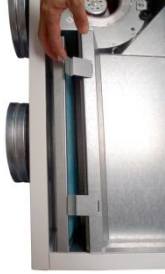

- Maintenance means a visual inspection of the unit, **regular filter change and cleaning of the heat recovery exchanger. Change the air filters not later than at intervals as indicated on the controller or earlier when needed and in case of contamination of the ambient environment.**
- During maintenance of the unit, observe personal hygiene rules and use protective equipment (mouth mask, containers for choked filters).
- Before you open the door of the HVAC unit, disconnect always the unit from the power supply (circuit breaker, fuse disconnect or by removing the plug from the socket – if connected in this way).
- During maintenance of the unit, observe safety instructions included in the Instructions (“Important warning”), follow basic rules for occupational safety and use appropriate means of access to the HVAC unit (ladders, mobile step-ladder).

7.2 Changing air filters G4/F7 – cloth type

- Change the filter cloth only if you do not suffer from allergic reactions in contact with dust particles. Avoid the change in the presence of such sensitive persons.
- Change the replacement filter cloth from the frame of filter in a well-ventilated room or outdoors.
- Before you remove the frame with cloth, it is recommended to prepare a sealed bag (e.g. paper bag, etc.) to bring it into a suitable area for change and to subsequently place the choked cloth - e.g. in a municipal waste.
- Before you open the under-ceiling unit, disconnect the condensate drain; in a colder year period, it is recommended to prepare a dish towel and a residual condensate collection container on the door of the unit.
- The change is made depending on dustiness of the external environment at an interval of 500 to 2,000 hours of operation (usually about 2 to 3 months). The recommended interval of inspection for the “D” control system is shown on controller display or on PC.

7.21 Change procedure

			
Remove the frame with filter from the unit	Unlock	Remove the frame of filter	Place the frame with filter cloth – in a disassembled condition on the bottom part of the cloth – G4 white and F7 smooth side to the grid



			
Properly fitted cloth G4 – white side to the frame grid	Fit the other part of the frame	Slide the frame with the grid facing the centre of the unit into the bottom guide	Push the frame under locking stops and snap in

The procedure is the same for all Adroit Pro units

7.3 Changing air filters G4/F7 – cartridge type

- Change the filter cartridge only if you do not suffer from allergic reactions in contact with dust particles. Avoid the change in the presence of such sensitive persons.
- Before you remove the filter cartridge from the unit, it is recommended to prepare a sealed bag (e.g. paper bag, etc.) to carry and place the cartridge - e.g. in a municipal waste.
- Before you open the under-ceiling unit, disconnect the condensate drain; in a colder year period, it is recommended to prepare a dish towel and a residual condensate collection container on the door of the unit.
- The change is made depending on dustiness of the external environment at an interval of 500 to 2,000 hours of operation (usually about 2 to 3 months).
- The recommended interval of inspection for the Web control system is shown on controller display or on PC. The cartridge is changed as a whole – i.e. piece / piece

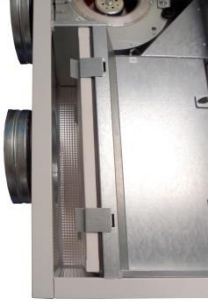
7.31 Change procedure

		
Filter cartridge in the unit	Unlock	Remove

For fitting, follow the procedure in the reverse order.

Fit the filter cartridge by direction of air flow – from the port to the unit – by arrow indicated on the cartridge.

7.4 Cleaning plastic heat recovery exchanger

The recommended period of cleaning of the exchanger is approximately 1 -2 years, depending on the nature of operating environment. If necessary, flush the heat recovery exchanger block several times with warm water with a detergent with maximum water temperature 40°C, ideally with temperature, which does not cause pain to your hands.

Do not expose the exchanger to the effects of UV and solar radiation; if necessary, store the exchanger in a dark room.

ATTENTION: Never use agents, which could contain organic solvents, for cleaning the exchanger – danger of irreversible damage to the exchanger!

7.41 Heat recovery exchanger release

Open the unit and unlock the heat recovery exchanger on both sides.

Note the position of heat recovery exchangers or exchanger (quantity depending on unit type) for continuity of seal.

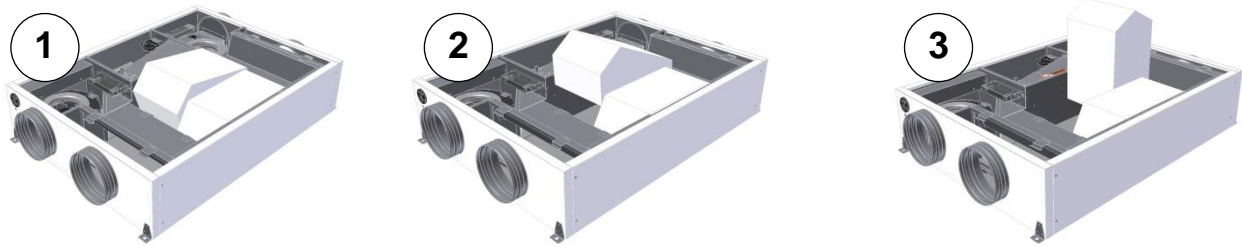

For inserting the heat recovery exchanger, follow the procedure in the reverse order. Before you insert the exchangers, it is recommended to apply a silicon oil on the seal to make the insertion easier, to increase the flexibility of seal and to extend its life time.

7.5 Controller cleaning

The unit controller is maintained in the same way as lighting switch – cleaning is possible only with a dry or slightly damp cloth; water must never get into the controller interior. The use of fluids, which could damage its surface (e.g. organic solvents), for cleaning is prohibited.

7.6 Cleaning other parts of the unit – minor maintenance

Check the following when changing the filter cloths or cartridges and each time you open the unit:

- Cleanliness of the condensate drain in the door or in the bottom of the unit.
Potential choking of the drain could cause serious complications
- Water in the condensate drain, mainly in summer and autumn.
When the water level is not sufficient, there is a danger of sucking in air from the sewer system - water.
- Condition of the door seals. It is recommended to apply a silicon oil on the seal at an interval of every one years to extend the life time
- If any of the sectors of the unit become clogged with dust, wipe it with a slightly damp cloth

7.7 Spare parts, repairs

All repairs within and outside the warranty period should be carried out by a specialised company and they cannot be carried out on a self-help basis.

7.8 Unit failures, safety instructions

As prevention, the most important is to regularly check that there are no failures or warnings indicated on the unit, which urge to inspect the unit. Early intervention allows you to use a simpler solution.

Unit fire procedure

- Disconnect the unit
- Carry out the rescue operations only with the use personal protective equipment (safety gloves, eye protection, breathing apparatus or mask with filter against organic vapours)
- If necessary, call the telephone number: 999

The unit is not intended to be exposed to humid environment or directly to water. Maintenance (Chapter 7.1) of the unit shall be carried out with a dry or slightly damp cloth.

8. Possible failures and solutions to such failures

8.1 Possible failures and solutions to such failures

Failure	Identification	Possible cause	Method for elimination of the failure
The unit does not start	<ul style="list-style-type: none"> After selecting the required power stage, the unit is still at idle 	<ul style="list-style-type: none"> Power supply is not connected 	<ul style="list-style-type: none"> Connect the unit to the grid (switch on the preliminary protective elements)
		<ul style="list-style-type: none"> Running of the unit is blocked by external input "enable running" (e.g. from fire valve, etc.) 	<ul style="list-style-type: none"> Check or contact the servicing worker
		<ul style="list-style-type: none"> Not found 	<ul style="list-style-type: none"> Disconnect the unit from the power supply and contact the servicing worker
The unit provides an insufficient volume of air	<ul style="list-style-type: none"> The unit provides a significantly smaller volume of air 	<ul style="list-style-type: none"> Choked filters 	<ul style="list-style-type: none"> Disconnect the unit from the power supply Change the filter cloth or cartridge In case of operation longer than approximately four years, clean the heat recovery exchanger/exchangers
		<ul style="list-style-type: none"> Mechanical barrier in fresh air inlet line or in supply air outlets 	<ul style="list-style-type: none"> Check that the fresh air inlet holes are not mechanically covered or the supply air outlets are not covered Eliminate potential barriers Verify the opening function of valves – visually, by listening
		<ul style="list-style-type: none"> Not found 	<ul style="list-style-type: none"> Disconnect the unit from the power supply and contact the servicing worker
The unit does not heat at all or insufficiently	<ul style="list-style-type: none"> After selecting the required temperature, cold air is still supplied The actual air temperature does not reach the setpoint value 	<ul style="list-style-type: none"> The power supply is not connected to the electrical heater 	<ul style="list-style-type: none"> Connect the unit to the grid (switch on the preliminary protective elements)
		<ul style="list-style-type: none"> Electrical heater thermal protection response 	<ul style="list-style-type: none"> Wait and if even after 1 hour, the failure is not automatically terminated, press the RESET button on the electrical heater. If this does not terminate the failure or in case of frequent repetition, contact the servicing worker
		<ul style="list-style-type: none"> Small maximum heater capacity 	<ul style="list-style-type: none"> No failure (wrongly designed, insufficient capacity)
		<ul style="list-style-type: none"> Not found 	<ul style="list-style-type: none"> Disconnect the unit from the power supply and contact the servicing worker
	<ul style="list-style-type: none"> After turning on the air heater, cold air is still supplied 	<ul style="list-style-type: none"> Throttle valve actuator not functional – still in one position 	<ul style="list-style-type: none"> Check that the TS (heating season) is set; if yes, call the servicing technician
		<ul style="list-style-type: none"> Aerated hot-water based heater 	<ul style="list-style-type: none"> Check the heating water temperature Vent
		<ul style="list-style-type: none"> Insufficient heating water temperature of the hot-water based heater 	<ul style="list-style-type: none"> Check the heating water temperature
		<ul style="list-style-type: none"> Insufficient heating water flow 	<ul style="list-style-type: none"> Check the condition of drainage filter at heating water inlet; clean the filter
		<ul style="list-style-type: none"> Small maximum heater capacity 	<ul style="list-style-type: none"> No failure (wrongly designed, insufficient capacity)
		<ul style="list-style-type: none"> Not found 	<ul style="list-style-type: none"> Disconnect the unit from the power supply and contact the servicing worker
Water dripping from the unit	<ul style="list-style-type: none"> During operation of the unit, water drops appear between the door and the frame of the unit 	<ul style="list-style-type: none"> Insufficiently watered siphon of the condensate drain 	<ul style="list-style-type: none"> Disconnect the unit from the power supply and water the siphon of the condensate drain
		<ul style="list-style-type: none"> The condensate drain is clogged with impurities 	<ul style="list-style-type: none"> Disconnect the unit from the power supply and clean the condensate drain including siphon
		<ul style="list-style-type: none"> The seal is damaged (the problem can be accompanied by a whistling sound caused by leakage sound flow) 	<ul style="list-style-type: none"> Disconnect the unit from the power supply and remove the seal
	<ul style="list-style-type: none"> Water drops appear at the point of connection of the condensate drain 	<ul style="list-style-type: none"> The seal or the condensate drain piping is damaged 	<ul style="list-style-type: none"> Disconnect the unit from the power supply and reseal the condensate drain
		<ul style="list-style-type: none"> Not found 	<ul style="list-style-type: none"> Disconnect the unit from the power supply and contact the servicing worker

9. Annexes

9.1 Product fiche

Supplier			Airflow Developments Ltd. Aidelle House, Lancaster Road, Cressex Business Park High Wycombe, Buckinghamshire, U.K T: 01494 525252 E: info@airflow.com W: airflow.com					
Model identifier			DUPLEXVENT DV170	DUPLEXVENT DV370	DUPLEXVENT DV570	DUPLEXVENT DV280	DUPLEXVENT DV380	DUPLEXVENT DV580
Model identifier			90000638 90000681 90000682 90000683	90000639 90000684 90000685 90000686	90000640 90000708 90000686 90000784	90000635 90000673 90000674 90000675	90000636 90000676 90000665 90000677	90000637 90000678 90000679 90000680
Specific energy consumption	SEC-W	kWh/(m2.a)	-17,47	-17,47	-17,34	-17,51	-17,41	-17,35
	SEC-A	kWh/(m2.a)	-42,17	-42,28	-42,03	-42,21	-42,22	-42,05
	SEC-C	kWh/(m2.a)	-80,69	-81,00	-80,56	-80,73	-80,93	-80,57
specific energy class	SEC-W		E	E	E	E	E	E
	SEC-A		A+	A+	A+	A+	A+	A+
	SEC-C		A+	A+	A+	A+	A+	A+
Declared typology			RVU/BVU	RVU/BVU	RVU/BVU	RVU/BVU	RVU/BVU	RVU/BVU
Type of drive			VSD	VSD	VSD	VSD	VSD	VSD
Type of heat recovery			Counter flow heat recovery core S6.A	Counter flow heat recovery core S6.A	Counter flow heat recovery core S3.B	Counter flow heat recovery core S3.B	Counter flow heat recovery core S3.B	Counterflow heat recovery core S3.B
Thermal efficiency of heat recovery	ηt	%	85	86	85	85	86	85
Maximum flow rate	Qm	m3/h	175	370	570	285	365	565
Electric power input at maximum flow rate		W	79	167	313	118	192	345
Sound power level LWA		dB	37	38	42	35	36	42
Reference flow rate	Qr	m3/s	0,034	0,072	0,111	0,055	0,071	0,113
Reference pressure difference		Pa	50	50	50	50	50	50
Specific power input	SPI	W/(m3/h)	0,248	0,255	0,258	0,245	0,26	0,257
Control factor	CTRL		0,65 Local demand control	0,65 Local demand control	0,65 Local demand control	0,65 Local demand control	0,65 Local demand control	0,65 Local demand control
Declared maximum internal leakage		%	2,5	2,5	2,2	2,5	2,5	2,2
Declared maximum external leakage		%	1,6	1,6	1,6	1,6	1,6	1,7
Position and description of visual filter warning			Control panel; "clogged filter"; Air filters in the unit must be changed regularly. Clogged air filters result in reduced performance and total efficiency of the ventilation unit.					
Internet address for pre-/disassembly instructions			www.airflow.com					
The annual electricity consumption	AEC-W	kWh/rok	1,31	1,35	1,37	1,30	1,38	1,36
	AEC-A	kWh/rok	1,76	1,80	1,82	1,75	1,83	1,81
	AEC-C	kWh/rok	7,13	7,17	7,19	7,12	7,20	7,18
The annual heating saved	AHC-W	kWh/rok	20,75	20,85	20,75	20,75	20,85	20,75
	AHC-A	kWh/rok	45,90	46,11	45,90	45,90	46,11	45,90
	AHC-C	kWh/rok	89,79	90,19	89,79	89,79	90,19	89,79
Warning: All types of control system that are built in within the unit commonly include at least two inputs, so the electrical signals from human operation of lights or other equipment, that automatically control the performance of the unit, can be connected. These inputs or other types of sensors must always be connected (e.g. CO2, VOC, RH etc.)								

9.4 Indicative wiring diagram of Web control system with WB1 Touch controller

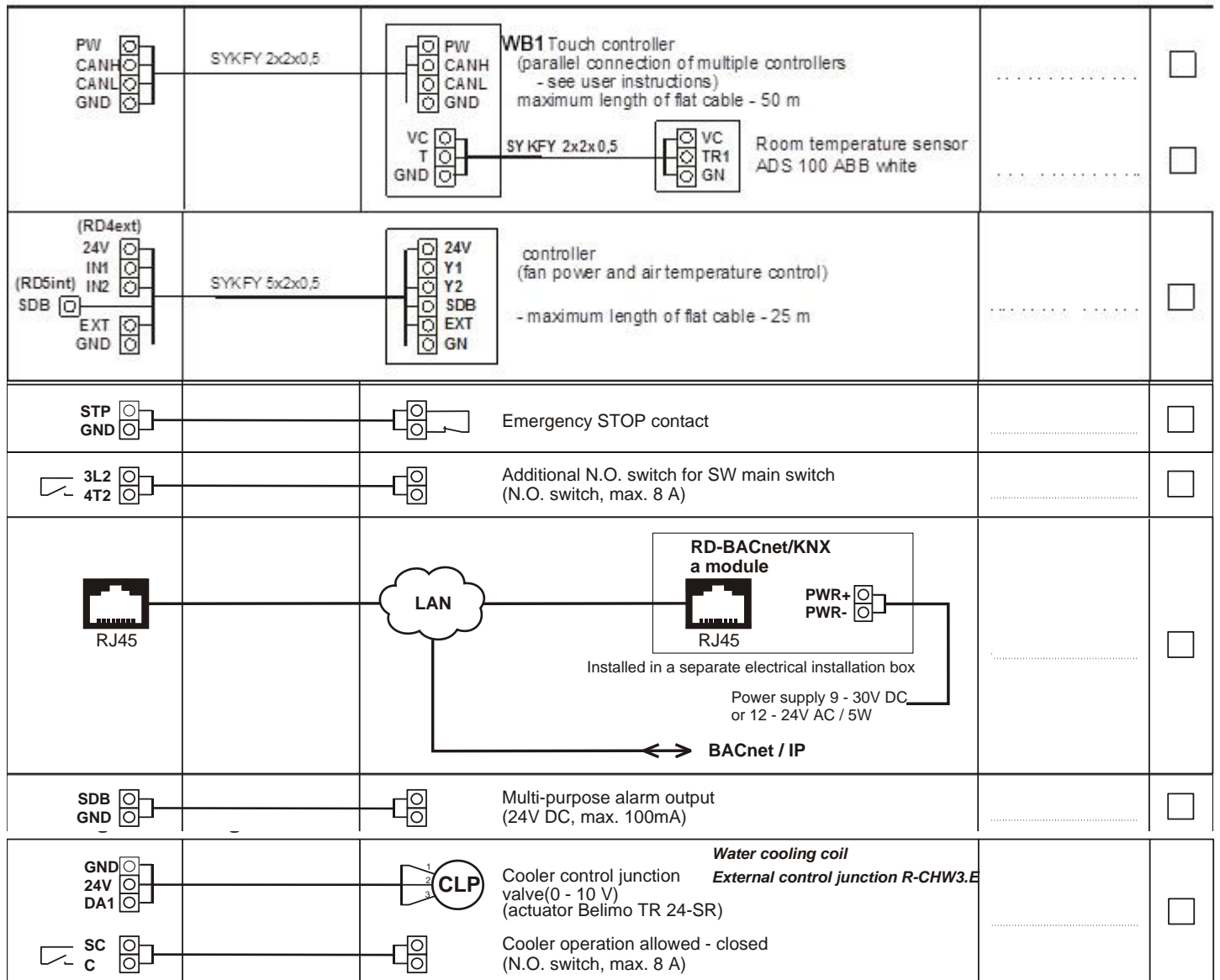

NOTE:

DUPLEXVENT Adroit Pro

DV170, DV280, DV370, DV380, DV570, DV580

Call: 01494 560800

Visit: airflow.com



Airflow Developments Limited
Aidelle House, Lancaster Road,
Cressex Business Park,
High Wycombe, Buckinghamshire,
United Kingdom, HP12 3QP

E-mail: info@airflow.com
Telephone: +44 (0) 1494 525252

airflow.com

© Airflow Developments Limited. Airflow Developments Limited reserve the right, in the interests of continuous development, to alter specifications without prior notice. All orders are accepted subject to our conditions of sale which are available on request



80000600 Issue 1 06/17